



Product Specification

XL280 Series

**280-Watt POE Ready
AC to DC Power Supplies**

705501 Rev 04-16-19

Notices

N2Power is a wholly owned subsidiary of Qualstar Corporation.

N2Power and the *N2Power* logo are registered trademarks of Qualstar Corporation.

Copyright© 2017 by Qualstar Corporation — All Rights Reserved

For warranty information refer to <http://www.qualstar.com/n2p-pss.php>

Information contained in this document is copyrighted by Qualstar Corporation and is intended for use by customers and prospective customers to evaluate and integrate our power supplies. Customers and prospective customers may reproduce this document as needed for these purposes. Reproduction in whole or in part for any other purpose or by any other party is prohibited without prior written permission from Qualstar Corporation.

Every effort has been made to keep the information contained in this document current and accurate as of the date of publication or revision. However, no guarantee is given or implied that the document is error-free or that it is accurate with regard to any specification.

N2Power reserves the right to modify the design or specification without notice. This specification may not be construed as a contractual obligation except as specifically agreed to by *N2Power* in writing at the time of order.

For information about this product specification, please write or call *N2Power* at:

N2Power

A Subsidiary of Qualstar
130 West Cochran St, Suite C
Simi Valley CA 93065

FAX: (805) 583-7749
Phone: (805) 583-7744

E-Mail: sales@n2power.com
www.n2power.com

Table of Contents

1.	Introduction.....	1-1
1.1	Introduction.....	1-1
1.2	Agency Compliance.....	1-2
2.	AC Input.....	2-1
2.1	Input Line Requirements.....	2-1
2.2	Input Over Current Protection.....	2-1
2.3	Inrush Current Limiting.....	2-1
2.4	Low Input Voltage.....	2-1
2.5	Leakage Current.....	2-2
2.6	Power-Factor.....	2-2
3.	DC Outputs.....	3-1
3.1	Output Voltage Regulation.....	3-1
3.2	No Load Operation.....	3-1
3.3	Output Current and Power.....	3-1
3.4	Output Ripple and Noise.....	3-3
3.5	Remote Sensing.....	3-4
3.6	V1 Over-Voltage Protection.....	3-5
3.7	Output Rise Time.....	3-5
3.8	Output Overshoot.....	3-5
3.9	Output Transients.....	3-5
3.10	Closed Loop Stability.....	3-5
3.11	Efficiency.....	3-6
3.12	Capacitive Load.....	3-7
3.13	Parallel Operation.....	3-7
3.14	Power Supply Protection.....	3-10
4.	General Specifications.....	4-1
4.1	Environmental.....	4-1
4.2	Component Derating.....	4-1
4.3	Mean Time between Failures.....	4-1
4.4	Labeling/Marking.....	4-2
4.5	Mounting.....	4-2
4.6	Physical Dimensions.....	4-3
4.7	Weight.....	4-3
4.8	Mating Connectors.....	4-4
4.9	Output Grounding.....	4-6
4.10	Signal Pin Definitions.....	4-6

5.	Timing and Control	5-1
5.1	Power Supply Timing.....	5-1
5.2	Power Good Output.....	5-1
5.3	PS_ON Input	5-2
5.4	Hold-Up Time (T5+T6).....	5-2
5.5	Output Rise Time	5-2
6.	Ordering Information	6-1

1.

Introduction

1.1 Introduction

This specification defines the design and performance characteristics of the XL280 series of open frame, single-phase (3-wire), universal input, power-factor corrected, multiple-output switch mode power supplies. This series is available with a main output voltage from 12V to 56V plus a 12V at 60W output that is electrically isolated from all of the other outputs. The 54V and 56V models have additional insulation to meet the 2250VDC output isolation to chassis requirements of IEEE Std 802.3-2008 Paragraph 33.4.1. These two products are therefore ideal for POE (Power Over Ethernet) applications. All models in this series have the following major features:





- Universal Input (100-240VAC)
- Total of 280W output power
- Model dependent 280W main output (12V, 24V, 48V, 54V, 56V)
- Optional Active current sharing on the main output
- +5V 1A Standby Supply (always on, optionally wire OR-able)
- Floating 12V 60W Output (may be used as + or - 12V, optionally wire OR-able)
- 54V and 56V models meet 2250VDC output isolation requirement
- 12V 12W Fan Output (wire OR-able)
- Remotely controlled outputs (except +5Vstandby)

This document includes information regarding installation, cooling requirements, connector configurations, electrical and signal specifications, and environmental ranges for storage and operation of the XL280 series of power supplies.



Figure 1-1 XL280 AC-DC Power Supply

1.2 Agency Compliance

Safety	Complies with Standard	Remarks
United States	UL 60950-1 Second Edition UL 62368-1 Second Edition (Information Technology Equipment)	Leakage Current – see table 2-2 Hi-pot – 2121vdc for 1 second
Canada	CSA 22.2: 60950-1	
EU Council	2006/95/EC	Low Voltage Directive
International	IEC 60950-1 (2005) Second Edition IEC 62368-1 (2014) Second Edition	
EMC	Complies with Standard	Remarks
United States	FCC part 15, subpart A	Conducted emissions Limits per CISPR 22 Class A* Tested to ANSI C63.4: 2003
EU Council	2004/108/EC	EMC Directive
International	EN 61204-3 (refers to the following) EN 55022 Class A EN 55024 (refers to the following) EN 61000-3-2 EN 61000-3-3 EN 61000-4-3 EN 61000-4-4 EN 61000-4-5 EN 61000-4-6 EN 61000-4-11	Low Voltage Power Supplies – DC Output Conducted emissions Limits per CISPR 22 Class A* Immunity Harmonic Current Emissions (Power Factor Correction – PFC) Voltage Fluctuations & Flicker Radiated Susceptibility Fast Transient/Burst Immunity Power Mains Surge Immunity RF Immunity Voltage Dips, Short Interruptions
Reduction of Hazardous Substances (RoHS)	Complies with Standard	Remarks
EU Council	2002/95/EC	RoHS Directive
Marks of Conformance		
United States & Canada		
Europe		
EU Council		
RoHS	 	

* with IEC AC inlet filter Delta P/N: 06DEEG3E

Table 1-1 Agency Compliance

2.

AC Input

2.1 Input Line Requirements

The XL280 is capable of supplying full rated power in continuous operation throughout the specified ranges of voltages and frequencies. The power supply will automatically recover from AC power loss and is capable of starting under maximum load at the minimum AC input voltage described below.

Parameter	Minimum	Nominal	Maximum
RMS Input Voltage	90 VAC	100-240 VAC	264 VAC
RMS Input Current	–	–	3.5 A @ 100 V
RMS Input Current	–	–	1.6 A @ 240 V
Input Frequency	47 Hz	50/60 Hz	63 Hz

Table 2-1 AC Input Parameters

2.2 Input Over Current Protection

The XL280 incorporates a primary AC line fuse for input over current protection to prevent damage to the power supply and meet product safety requirements as outlined in Section 1.2.

2.3 Inrush Current Limiting

The cold-start inrush current at a 90-degree phase angle (the AC switch is closed at the peak of the AC waveform) is limited to 14-amps peak at 240 VAC input voltage and 7-amps peak at 120 VAC @ 25C.

Repetitive ON/OFF cycling of the AC input voltage will not damage the power supply or cause the input fuse to fail as long as the power remains off for two or more seconds when the outputs are unloaded.

2.4 Low Input Voltage

The application of an input voltage below the minimums specified in Table 2-1 shall not cause damage to the power supply.

2.5 Leakage Current

The leakage current from AC line or AC Neutral inputs to Protective Earth varies linearly with the input voltage and frequency (see operating column of Table 2-2). The leakage currents of multiple power supplies are additive. Consult the appropriate electrical safety specification for the maximum leakage current permitted in your product. The leakage current will always go to zero when a DPDT switch simultaneously disconnects both the line and neutral circuits. A single fault can occur when the AC power is applied to only the Neutral input terminal.

Line Voltage Frequency	Operating	Single Fault (see text)
115VAC, 60Hz	0.40mA	0.60mA
240VAC, 60Hz	0.83mA	1.20mA
240VAC, 50Hz	0.69mA	1.00mA

Table 2-2 Leakage Current – Single XL280

2.6 Power-Factor

The input power-factor exceeds 0.98 from 100VAC to 240VAC at full-load.

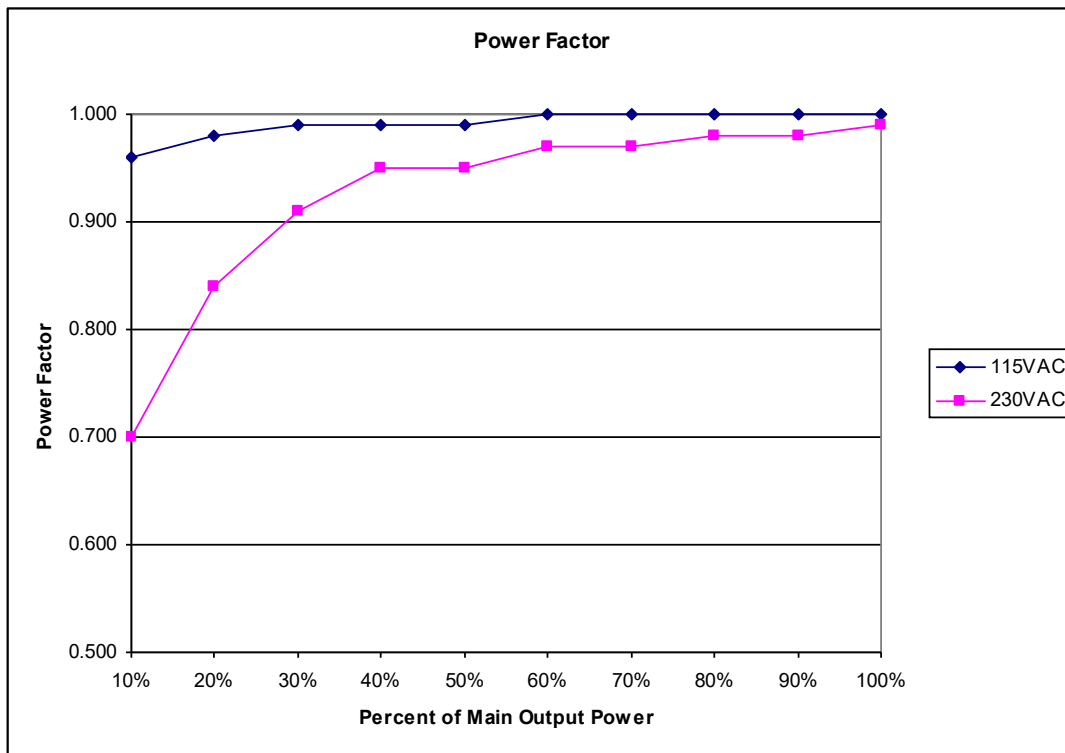

Figure 2-1 XL280 Typical Power Factor

3.

DC Outputs

3.1 Output Voltage Regulation

Except as specified below, the DC output voltages shall remain within the Minimum and Maximum limits of Table 3-1 when measured at connector J2 under all specified line, load and environmental conditions contained herein.

Model	Output	Rated Voltage	Regulation	Minimum (VDC)	Nominal (VDC)	Maximum (VDC)	Remote Sense
XL280-12		+12V	±3%	11.640	12.000	12.360	V1/RTN
XL280-24		+24V	±3%	23.280	24.000	24.720	V1/RTN
XL280-48	V1	+48V	±3%	46.560	48.000	49.440	V1/RTN
XL280-54		+54V	±3%	52.380	54.000	55.620	V1/RTN
XL280-56		+56V	±3%	54.320	56.000	57.680	V1/RTN
	V2	+12V	±5%	11.40	12.00	12.60	
All	V3	+12V	±5%	11.40	12.00	12.60	
	V4	+5V _{standby}	±5%	4.75	5.00	5.25	

Table 3-1 Output Voltage Specifications

3.2 No Load Operation

The power supply will operate with reduced output voltage regulation of +/-5% on V1 and V2 with all outputs unloaded. This no load condition will not damage the XL280 or cause a hazardous condition. The power supply will remain stable and operate normally after application of the minimum loads specified in Table 3-2.

CAUTION

Remove AC power prior to attaching or removing loads.

3.3 Output Current and Power

The maximum available output power is always a function of the cooling airflow and temperature. The total available output power is reduced with unrestricted natural convection cooling at an ambient temperature of 50°C or less (see Section 3.3.1). The total combined (V1 through V4) output power must be limited to 280-watts of continuous power under the cooling conditions specified in Section 3.3.1 below.

3.3.1 Output Power and Cooling

The maximum combined output power is limited to 280-watts with 10 CFM of forced air-cooling at no more than 50°C. Cooling efficiency is best with airflow down onto the top or into the J1 end of the XL280. Airflow into the J2 end is less efficient, but does work. The 5Vstandby output is limited to 5-watts under the same conditions. Under these cooling conditions, the individual outputs have the following limitations:

	Output	Rated Voltage	Minimum Load	Maximum Load	Maximum Watts
XL280-12		+12V	0.4 A	23.3 A*	280
XL280-24		+24V	0.2 A	11.6 A*	280
XL280-48	V1	+48V	0.1 A	5.8 A*	280
XL280-54		+54V	0.1 A	5.2 A*	280
XL280-56		+56V	0.1 A	5.0 A*	280
	V2	+12V	0.0 A	5.0 A	60
All	V3	+12V	0.0 A	1.0 A	12
	V4	+5V _{standby}	0.1 A	1.0 A	5

* Also pulse rated, see Section 3.3.3 below

Table 3-2 Individual Min/Max Load Currents

3.3.2 Natural Convection Cooling

With unrestricted natural convection cooling, the maximum combined output power of V1 through V3 is reduced from 280-watts to 100-watts while the +5V_{standby} output is limited to 0.5A for a total of 102.5-watts.

3.3.3 V1 Output Pulse Current

In addition to its continuous rating of 280-watts, the V1 output can provide a peak output of 360-watts for 0.5-seconds provided the load pulse is not repeated for at least 20-seconds. The total combined average power must still be limited to 280-watts.

3.3.4 High Temperature Derating

The XL280 can be operated at elevated temperatures by derating the total average output power by 2.5% per degree-centigrade from 50°C to 70°C (see Figure 3-1). Operating within this elevated temperature range still requires cooling air flow as described in Section 3.3.1.

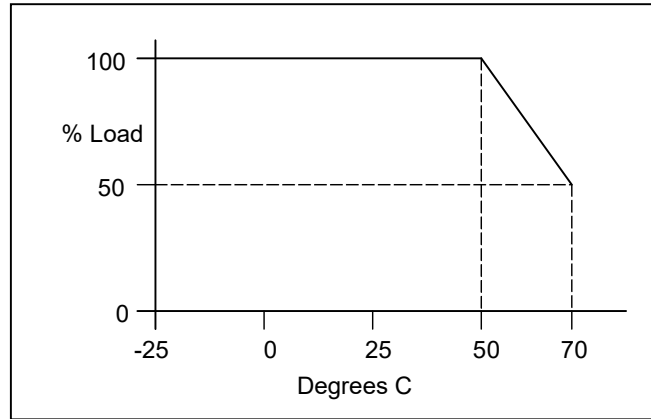

Figure 3-1 Output Power vs. Ambient Temperature Envelope

3.4 Output Ripple and Noise

Output ripple voltage and noise are defined as periodic or random signals over a frequency band of 10 Hz to 20 MHz. Measurements are to be made with an oscilloscope with at least 20 MHz bandwidth. The measured output must be bypassed at the connector with a 0.1 μF ceramic disk capacitor and a 10μF tantalum capacitor to simulate system loading (see Figure 3-2). Ripple and noise shall not exceed the limits specified in Table 3-3 under any condition of line voltage and frequency specified in Section 2.1 and DC loading specified in Table 3-2.

Output	Voltage	Maximum Ripple+Noise (peak-to-peak)
V1	12-56 V	1% of V1
V2, V3	+12 V	120 mV
V4	+5 V _{standby}	50 mV

Table 3-3 Output Ripple and Noise Specification

3.4.1 Ripple and Noise Measurement

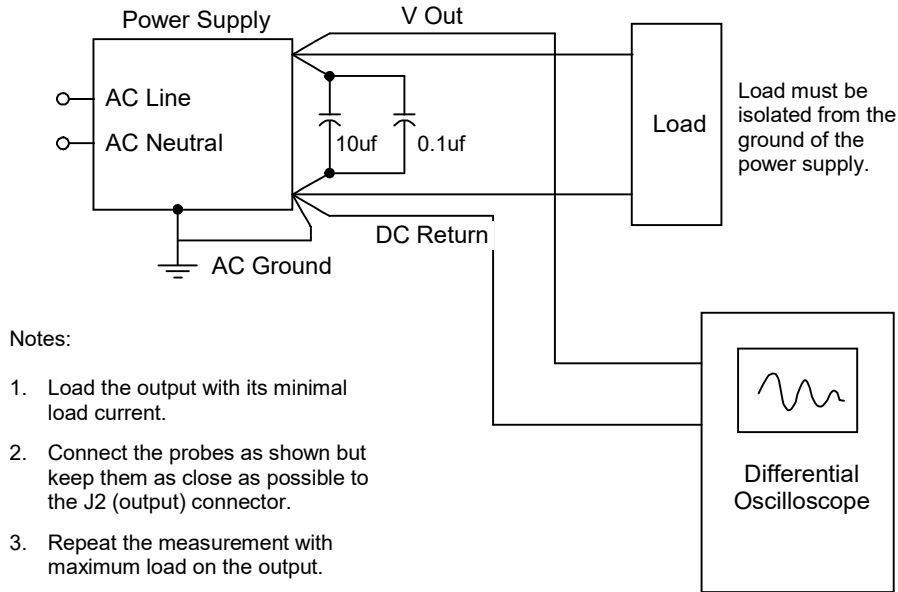

Figure 3-2 Ripple and Noise Measurement Setup

3.5 Remote Sensing

A remote sense inputs are provided to compensate for the normal voltage drops in the external V1 output wiring. If the V1 Sense inputs are left open, the V1 output will meet its load regulation specification only at the J2 terminals. Connecting the +V1 Sense and -V1 Sense pins to the load will raise the V1 output voltage to help compensate for the voltage drop in the external V1 wiring. The voltage difference between the +V1 Sense and +V1 output pins must be limited to 0.6-volts as must the difference between the -V1 Sense and RETURN pins. Figure 3-3 shows the optional remote sensing connections. Refer to Table 4-7 for the pin definition of the XL280 connectors.

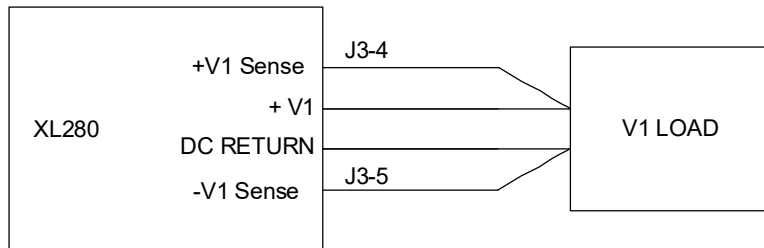

Figure 3-3 V1 Remote Sensing

3.6 V1 Over-Voltage Protection

When an over-voltage condition occurs on V1, the power supply will shut down and will not restart until AC power is turned off and back on. The XL280 will shut down under the following V1 over-voltage conditions:

Rated Voltage	Minimum	Nominal	Maximum
+12V	13.5V	15.0V	16.5V
+24V	27.0V	30.0V	33.0V
+48V	54.0V	60.0V	66.0V
+54V	60.8V	67.5V	74.3V
+56V	63.0V	70.0V	77.0V

Table 3-4 Over-Voltage Protection Thresholds

3.7 Output Rise Time

All output voltages shall rise from 10% to 90% of nominal output voltage (as specified in Table 3-1) within 0.2ms to 20ms. The rising output waveforms are monotonic from 10% to 90% under the maximum steady-state load conditions specified in Table 3-2.

3.8 Output Overshoot

The output voltages may overshoot less than 10% above the nominal voltage upon the application or removal of the input power. No opposite polarity voltage is present on any output during turn-on or turn-off.

3.9 Output Transients

The maximum output voltage transient caused by stepped load changes will not exceed the output voltage regulation limits by more than 5% of the nominal output voltage. With an AC input as specified in Section 2.1, the power supply will remain stable when subjected to the load transients described below:

- Load changes between 75% and 100% on any output from 50 to 333 cycles per second
- Transient load slew rate used in verification testing is 1.0-amp per microsecond
- Capacitive loading per Table 3-5

3.10 Closed Loop Stability

The power supply is unconditionally stable under all line/load/transient load conditions including the capacitive loads specified in Table 3-5. The power supply shall exhibit a minimum of 45-degrees phase margin and 6 dB gain margin.

3.11 Efficiency

The V1 output of the XL280-48 CS is typically 90% efficient at full load with an input voltage of 230VAC 60Hz and 10 CFM of cooling air at 25°C. Lower-voltage models are slightly less efficient. Efficiency is calculated as the total DC output power divided by the RMS input power. The three curves that follow are from models with the current-sharing option. Non-current-sharing models are slightly more efficient.

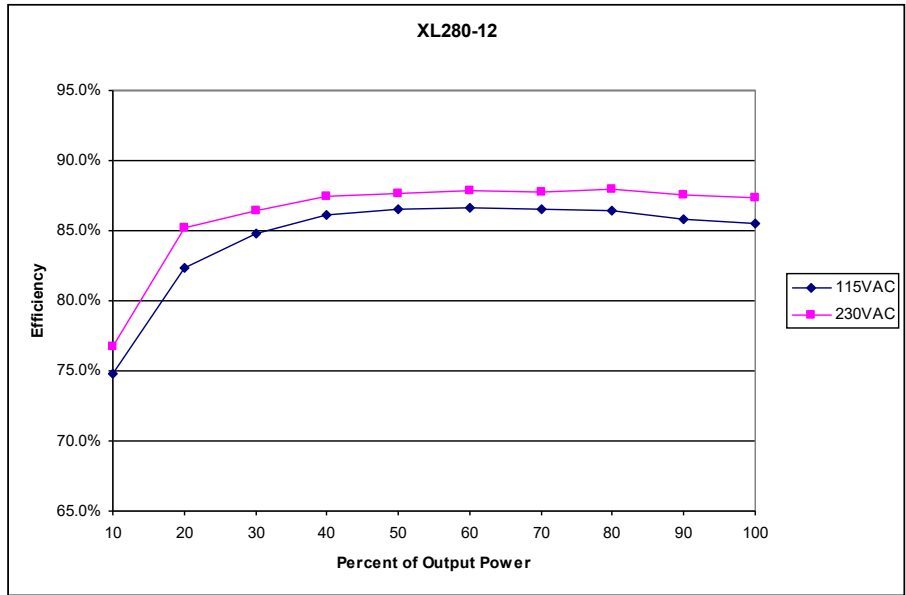

Figure 3-4 XL280-12 CS Typical Efficiency (with ORing MOSFET)

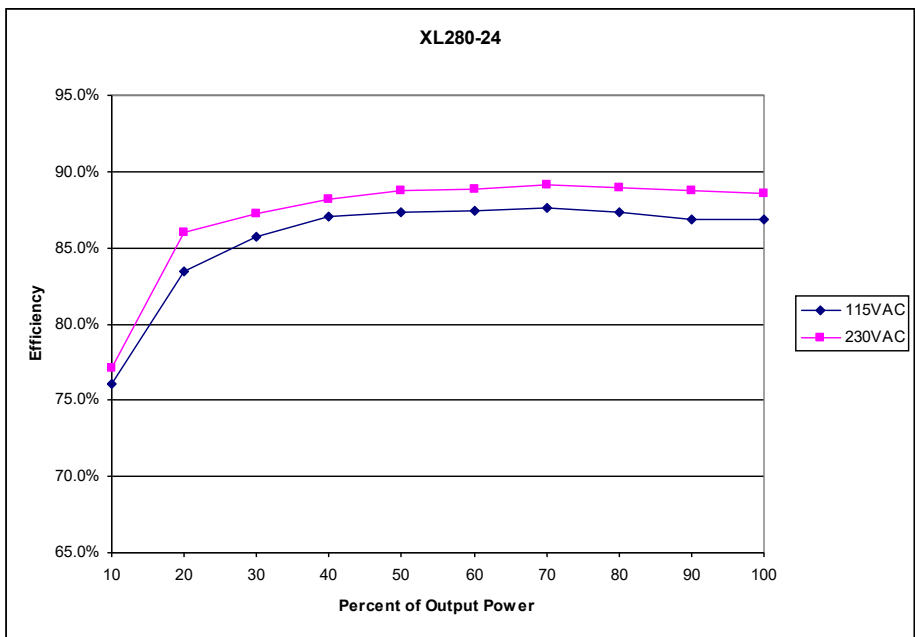

Figure 3-5 XL280-24 CS Typical Efficiency (with ORing Diode)

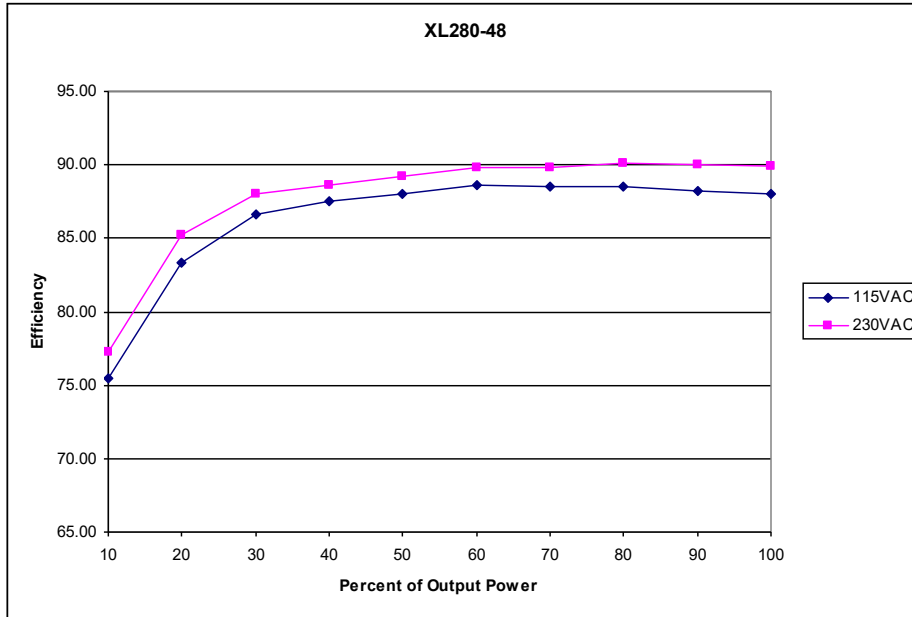

Figure 3-6 Typical XL280-48 CS Efficiency (with ORing Diode)

3.12 Capacitive Load

The XL280 will startup and operate normally with external load capacitance as shown in Table 3-5. The power supply will operate with greater capacitive loading but were not tested.

Output	Voltage	Capacitive Load (µf)
V1	+12V	4,000µF
	+24V	2,000µF
	+48V	500µF
	+54V	350µF
	+56V	350µF
V2	+12V	1,000µF
V3	+12V	1,000µF
V4	+5V _{standby}	100µF

Table 3-5 Capacitive Loading

3.13 Parallel Operation

Each XL280 model is available with or without active current sharing. With active current sharing the V1 output of two, three or four standard XL280s may be connected in parallel to provide higher V1 output power. They can also be used in an N+1 configuration to provide higher output power and greater reliability. Each model has a built-in output OR-ing diode (diode or actively switched MOSFET) and a

Current Share signal for parallel operation. Remote sensing may still be used in parallel operation.

The obvious benefits of parallel operation are increased reliability through redundancy or increased output power. An additional benefit is increased reliability (MTBF increases) whenever the power of an individual supply is reduced. There is about a 1.2% loss in V1 efficiency in the OR-ing diodes of current sharing models (2.5-3.5W). V2 can experience about a 2.5W loss in the OR-ing diode at 5A while V3 will experience about a 0.5W loss.

XL280s running in parallel are capable of starting with a total load that exceeds the capability of an individual unit, however, the rising output waveform may not be monotonic. They are also fully compatible with hot swapping and will tolerate the dramatic load fluctuations encountered in an N+1 redundant configuration when supplies are removed and replaced. Because of the inherent limitations of current sharing, it is recommended that the total load not exceed 92%-94% of the sum of the rated outputs (see Table 3-6). Assuming all XL280 output power is dedicated to the main output (no +12V or +5 V_{standby} use), the following table lists possible total system output power.

Number of XL280s	N Configuration	N + 1 Configuration
1	280-watts	N/A
2	520-watts	280-watts
3	770-watts	520-watts
4	1015-watts	770-watts

Table 3-6 Total Output Power in N and N+1 Configurations

3.13.1 Current Sharing Connections

The Current Share signal (see Table 4-7) of each supply operating in parallel must be connected together. The output voltage of multiple power supplies in parallel is generally slightly higher than that of the supply with the highest stand-alone output voltage.

Current sharing does not require the Remote Sense signals be connected together, but the sharing accuracy may not meet published specification unless they are also connected together. See Figure 3-7 for an example of wiring two XL280's in parallel. Three and four supplies would be wired in a like manner with all four V1 Current Share signals tied together.

With active current sharing systems, the Current Share signal is a high-impedance analog output/input on each supply. This signal is quite susceptible to noise pickup and care must be used in wiring the Current Share signals of multiple supplies together. Any external capacitance on this signal will cause the output voltages of all supplies to rise and will compromise sharing accuracy. Do not connect any capacitance to this signal.

It is recommended that a twisted pair of wires be used to daisy-chain the Current Share signal and its adjacent DC Return between each unit. See Table 4-7 for pinout information.

The current sharing signal is referenced to the same DC Return as the V1 output. It is imperative that the ground wiring from the load to each shared supply be of equal length and have the lowest possible resistance. This means five individual 18 AWG wires should be run from J2 of each supply to a star ground terminal or ground plane at the load.

Power Good signals must not be wire ORed together. Each individual Power Good signal should be monitored separately by the user's system.

3.13.2 Current Share Accuracy

When all the current share signals are connected together and all the Remote Sense signals are connected together, the load delivered by any two of the sharing supplies will not differ by more than 10% at full load. The sharing accuracy decreases with lower loads.

3.13.3 V4 (+5 V_{standby}) Parallel Operation

The V4 output on current share models has a series Schottky rectifier just before the output connector that allows this output to be connected in parallel with the same output on like supplies. By doing so, the V4 output will remain alive as long as one of the paralleled supplies is functioning. The output current rating does not increase beyond the single supply rating. The diode dissipation at 1A is about 0.5-watts.

3.13.4 V2 and V3 (+12V) Parallel Operation

The V2 and V3 outputs both have a series rectifier that allows these outputs to be paralleled with the same output on like supplies. By doing so, the V2 and/or V3 outputs will remain alive as long as one of the paralleled supplies is functioning. The output current rating does not increase beyond the 1A rating. The V2 OR-ing diode dissipation is about 2.5-watts at 5A, while the V3 diode dissipates about 0.5W at 1A.

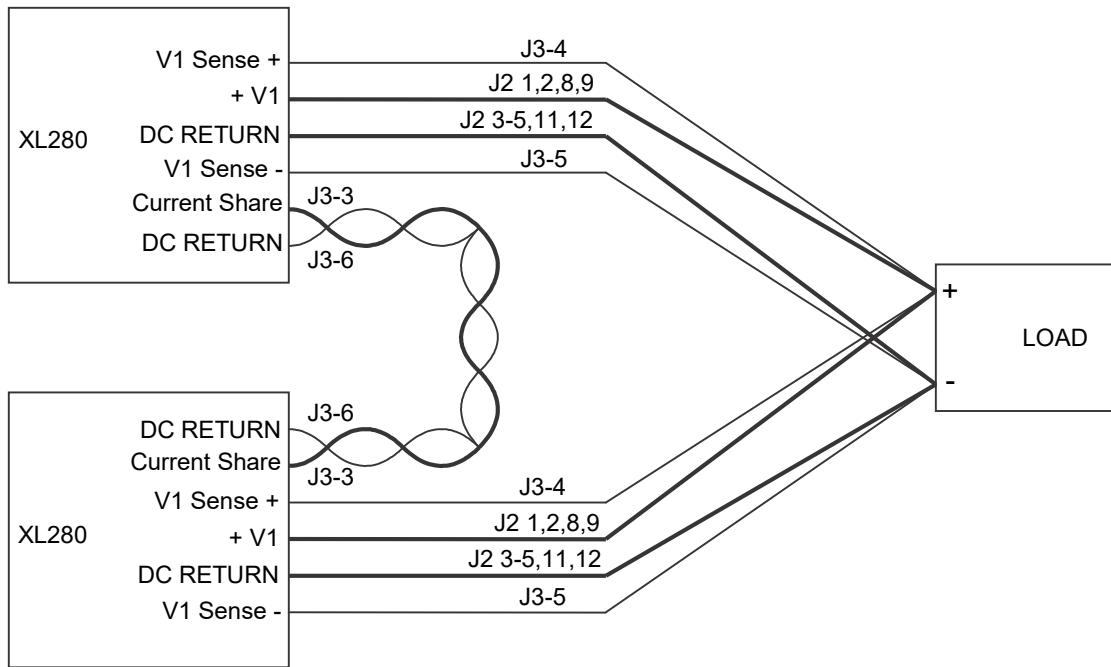

Figure 3-7 Current Sharing Wiring Example

3.14 Power Supply Protection

There are several different protection circuits designed to protect the load and the XL280 from component failures and extraordinary circumstances.

3.14.1 Over Temperature Protection

If the XL280 is operated without adequate cooling, it will sense an over-temperature condition and simultaneously shut down the V1, V2 and V3 outputs. There are two possible fault-conditions: excessive PFC MOSFET or main transformer temperatures. Following an over-temperature fault, the XL280 will automatically restart after it has cooled down to below its maximum temperature limits.

The V4 output has an independent over-temperature protection circuit. An over-temperature condition on the V4 output will bring down the entire power supply. It also recovers on its own after cooling down.

3.14.2 V1 Voltage Protection

Excessive V1 output voltage (see Section 3.6 for details) will shut-down the V1, V2 and V3 outputs. The XL280 will not restart until AC power is turned off and back on. The +5V_{standby} output will remain on after an over-voltage shut-down.

3.14.3 Over-Load Protection

V1 load currents in excess of 120% of the rated output lasting more than 500-milliseconds will cause the V1 through V3 outputs to shut down. Steady-state loads below 93% with pulses of up to 150% for less than 500-milliseconds will be tolerated

providing the duty-cycle does not exceed 2.5%. The average RMS output power (of all three outputs) must still be limited to 280-watts. A combined V1, V2 and V3 load exceeding 335W will also shut down these outputs.

After shutting down from overload, the XL280 automatically attempts to restart itself every second. It will succeed if the sum of the V1 through V3 loads is reduced below the XL280's maximum rated load power.

An overload on the either or both the V2 (5.5A) or V3 (1.5A) outputs will not cause V1 or V4 to shut down and the shorted output will resume normal operation after the short circuit is removed. An overload on the +5V_{standby} output (1.5A) will completely disable the power supply, but it will recover after the overload is removed.

4.

General Specifications

4.1 Environmental

The XL280 meets or exceeds the following environmental specifications:

Parameter	Conditions	Specification	Remarks
Temperature	Operating	-25°C to 50°C	See cooling requirements
	Non-Operating	-40°C to 85°C	
Relative Humidity	Operating	95% Maximum	Non-Condensing
	Non-Operating	95% Maximum	Non-Condensing
Altitude	Operating	6,561 feet MSL Max.	2,000 meters
	Non-Operating	50,000 feet MSL Max.	15,240 meters
Vibration	No damage	2.4G RMS Maximum	5-500Hz, 10-min. each axis per MIL-PRF-28800F: 3.8.4.1 (Class 3,4)
Mechanical Shock	No damage	30G half-sine, 11mS	Six shocks each axis per MIL-PRF-28800F: 4.5.5.4.1

Table 4-1 Environmental Specifications

4.2 Component Derating

The XL280 was designed with the following component-derating guidelines at an operating ambient temperature of 50°C: semiconductor junction temperatures shall not exceed ninety (90) percent of manufacturer's rating. Inductor winding temperatures shall not exceed safety agency requirements. Electrolytic capacitor case temperatures shall not exceed 95% of rated temperature. Resistor power dissipation shall not exceed 70% of rated while other components will not be operated at more than 90% of their rated voltage or current.

4.3 Mean Time between Failures

The calculated MTBF of the power supply is equal to or greater than 546,000 hours of continuous operation at maximum output loading and worst case input line voltage with 10-CFM of forced-air cooling at 25°C. N2Power does not warrant the MTBF to be representative of any particular unit. The MTBF of the power supply is calculated with an 80% confidence level in accordance with Bellcore, SR-332, Issue 2. Actual failure rates vary from unit to unit.

4.4 Labeling/Marking

The power supply is marked and labeled with the N2Power logo and part number, model number, input and output specifications, production code, appropriate safety agency logos, CE mark, patent number (if any apply), and country of origin. See Figure 4-1.

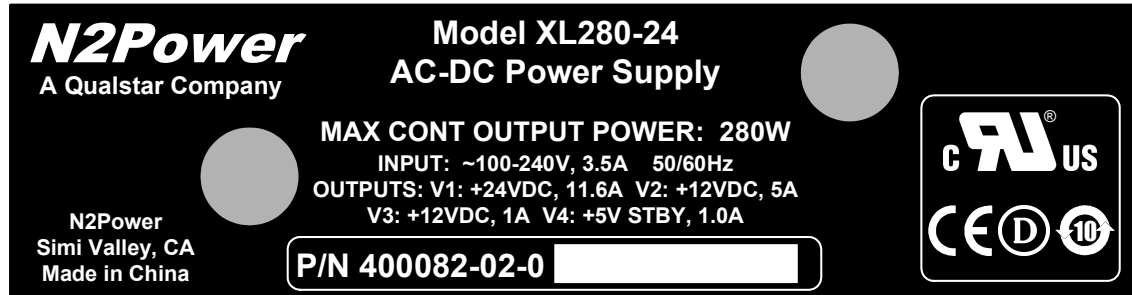

Figure 4-1 Sample XL280 Label

4.5 Mounting

The XL280 may be mounted in any attitude but must be mounted on all four corners using M3 or 6-32 UNC hardware. Any mounting hardware (screw heads, washers, standoffs, etc.) must not exceed .282-inches (7.16-mm) in diameter to assure adequate safety agency spacing requirements with components and the printed circuit board traces. A standoff height of 0.25-inches minimum should be used. When using standoffs less than 0.375" in length, place a thin insulator (polyester, fish paper or equivalent) UL rated 94V-2 minimum between the XL280 and the mounting chassis (refer to applicable UL standard for clearance requirements).

4.6 Physical Dimensions

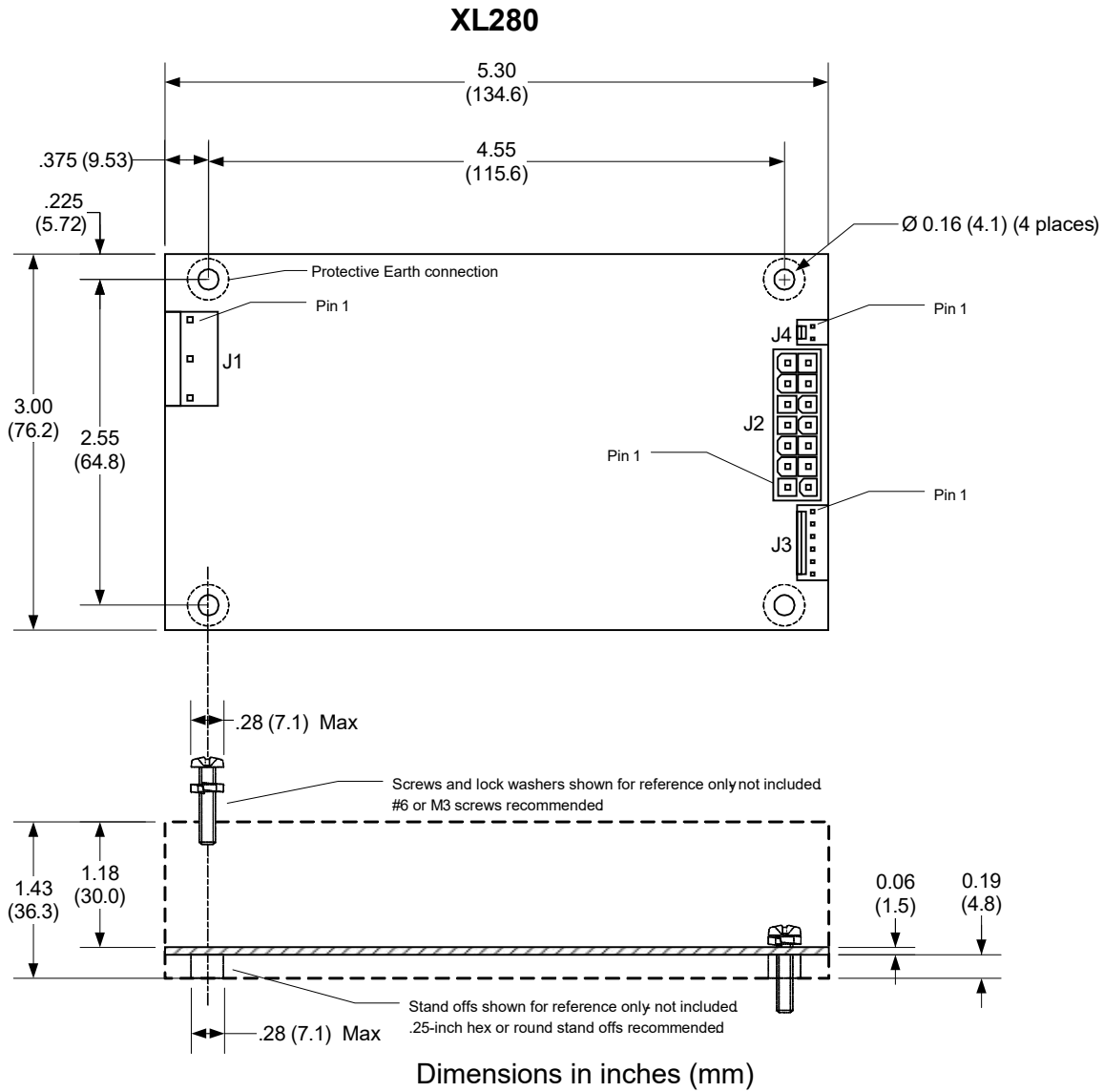

Figure 4-2 Dimensions

4.7 Weight

Weight	Units
0.87	Pounds
13.8	Ounces
0.39	Kilograms

Table 4-2 Weight of Individual Supply

4.8 Mating Connectors

The user must furnish all mating connectors. The mating connectors must meet the requirements of all applicable safety agencies (notably UL). Molex™ (Molex is a trademark of the Molex Corporation) did not change their part numbers when they took the lead out of their contacts. The Molex part numbers in this section should yield RoHS compliant contacts. The largest wire size accepted by each contact should be used for all power connections to help dissipate the heat generated by the resistive connections.

Note that the female contacts that mate to the power supply are only rated for 25-30 mating cycles. Excessive mating cycles will cause a dramatic increase in terminal resistance resulting in local heating that will cause eventual failure of the mating terminal and possibly the header on the power supply.

CAUTION

The pin-1 location differs amongst connector manufacturers. Sometimes pin-1 differs between the header (on the power supply) and the mating housing from the same manufacturer. Disregard the manufacturer's pin-1 location and follow only the pin-1 locations in Figure 4.2

4.8.1 AC Input Mating Connector J1

The AC input connector to the XL280 is a 5-pin Molex KK-156 style header with 0.156" centers. The pins 2 and 4 are omitted to provide adequate insulation spacing. The Molex part numbers for the mating housing and crimp-style snap-in terminals are listed below. There may be equivalent connectors available from other manufacturers.

J1	Molex P/Ns
Connector Circuits (pins)	3 of 5
Mating Housing	09-50-8051
Crimp Terminal (tin)	08-50-0113
Rated Contact Current	6.3 A @ AWG 20
Rated Wire Size	AWG 18 or 20

Table 4-3 J1 Mating Connector

4.8.2 DC Output Connector J2

The DC output connector is a Molex Mini-Fit, Jr.® header with 0.165” centers. The Molex part numbers for the mating housing and crimp-style snap-in terminals are listed below. There may be equivalent connectors available from other manufacturers. AWG 16 wire with the 39-00-0078 contact is recommended.

J2	Molex P/N	Rated AWG
Connector Circuits (pins)	14	
Mating Housing	39-01-2140	
Rated Contact Current	9.0 A	16
Recommended Crimp Terminal	39-00-0078	16
Alternate Crimp Terminal	39-00-0039	18-24

Table 4-4 J2 Mating Connector

4.8.3 Remote Sense Connector J3

The Remote Sense connector is a Molex KK-100 style header with 0.100” centers. The Molex part numbers for the mating housing and crimp-style snap-in terminals are listed below. There may be equivalent connectors available from other manufacturers.

J3	Molex P/Ns
Connector Circuits (pins)	6
Mating Housing	22-01-3067
Crimp terminal (tin)	08-65-0816
Rated Contact Current	2.5 A
Rated Wire Size	AWG 22 thru 30

Table 4-5 J3 Mating Connector

4.8.4 Fan Connector J4

The Fan connector is a Molex KK-100 style header with 0.100” centers. The Molex part numbers for the mating housing and crimp-style snap-in terminals are listed below. There may be equivalent connectors available from other manufacturers.

J4	Molex P/Ns
Connector Circuits (pins)	2
Mating Housing	22-01-3027
Crimp terminal (tin)	08-65-0816
Rated Contact Current	2.5 A
Rated Wire Size	AWG 22 thru 30

Table 4-6 J3 Mating Connector

4.9 Output Grounding

The DC RETURN signal may be connected to the power supply chassis ground (protective earth) at the plated-through mounting hole nearest the J1 input connector.

The V2 and V3 outputs have a floating DC RETURN at J2-7 and J4-2, separate from the V1 return. The V2/V3 RETURN may be connected to DC RETURN. It is possible to connect +V2 to DC RETURN for a negative 12V output at J2-7 and J2-4. In this case, do not connect +V3 to either V2 or DC RETURN.

4.10 Signal Pin Definitions

- Identical signal names are all connected together (on any connector)
- The Protective Earth connection is provided at both the mounting hole near J1, pin-1.
- Refer to Figure 4-2 for connector and pin-1 locations

Pin	Signal
J1-1	Protective Earth (PE)
J1-3	AC Neutral Input
J1-5	AC Line Input
J2-1	+V1
J2-2	+V1
J2-3	DC RETURN (0V)
J2-4	DC RETURN (0V)
J2-5	DC RETURN (0V)
J2-6	V4 (+5VSB)
J2-7	V2/V3 RETURN (0V)
J2-8	+V1
J2-9	+V1
J2-10	+V1
J2-11	DC RETURN (0V)
J2-12	DC RETURN (0V)
J2-13	No Connection
J2-14	V2 (+12V)
J3-1	PS_ON/ Input
J3-2	Power Good Output
J3-3	IShare Input/Output
J3-4	+V1 Sense Input
J3-5	-V1 Sense Input
J3-6	DC RETURN (0V)
J4-1	V3 (+12V FAN)
J4-2	V2/V3 RETURN (0V)

Table 4-7 I/O Pin Definitions

5.

Timing and Control

5.1 Power Supply Timing

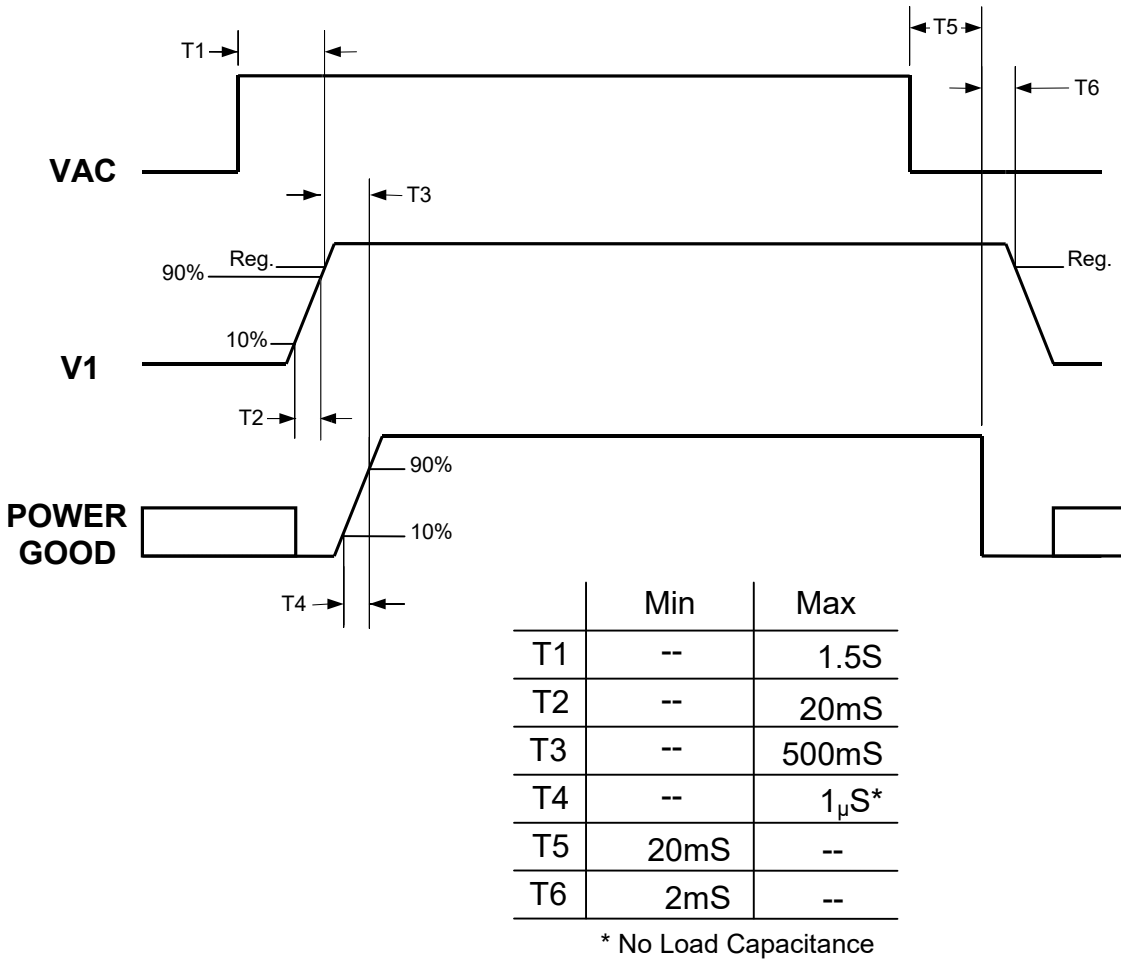

Figure 5-1 XL280 Timing Diagram

5.2 Power Good Output

The Power Good signal provides a high logic level to indicate the DC outputs are within their regulation limits and that sufficient mains energy is stored by the power supply to ensure continuous power operation within specification for the duration of the hold-up time. When the AC power is removed for a period longer than 20ms, the Power Good signal transitions to a low logic level. The Power Good signal is capable of sinking 6mA and requires an external pull-up resistor (1K-5K) connected to +5 V_{standby}.

The Power Good signal also goes false whenever the V1 output voltage falls below 90% of nominal value. The Power Good signal will be automatically restored if the output rises above 93% of the nominal.

5.3 PS_ON Input

The V1, V2 and V3 outputs are enabled whenever the PS_ON/ input (J3 pin-1) is grounded to DC RETURN (J3 pin-6). Opening the PS_ON/ input will disable the three outputs. The PS_ON/ input has an internal 2K-ohm pull-up resistor to +5 V_{standby}.

The special order S91 option changes the logic sense of the PS_ON input from low-true with a pull-up resistor to high-true with a 10 K-ohm pull-down resistor. Consult sales for details.

5.4 Hold-Up Time (T5+T6)

The power supply will maintain output regulation (per Table 3-1) despite a momentary loss of input power (lasting up to 22-milliseconds) when operating at any rated input voltage (per Table 3-1) at any rated load condition (per Table 3-2).

5.5 Output Rise Time

For single supply applications, all output voltages shall rise monotonically (always positive slope) from 10% to 90% of their nominal output voltage (as specified in Table 3-1) within 0.2ms to 20ms under any loading conditions specified in Section 3.3.1.

6.

Ordering Information

The following table provides the N2Power part number that should appear on your purchase order and will appear on any N2Power correspondence:

Model Number	V1	N2Power Part Number
Without active current sharing (lower cost)		
XL280-12	12V	400082-01-2
XL280-24	24V	400082-02-0
XL280-48	48V	400082-03-4
XL280-54	54V POE	400082-04-6
XL280-56	56V POE	400082-05-3
With active current sharing		
XL280-12 CS	12V	400081-01-4
XL280-24 CS	24V	400081-02-2
XL280-48 CS	48V	400081-03-0
XL280-54 CS	54V POE	400081-04-8
XL280-56 CS	56V POE	400081-05-5

Table 6-1 Ordering Information

POE (Power Over Ethernet) models feature 2250VDC output isolation.

All XL280 Models are RoHS compliant.

For warranty information refer to www.n2power.com.

Direct all questions, orders or requests for quotation as follows:

N2Power Order Desk: orders@n2power.com
Sales: sales@n2power.com
805-583-7744 x122
Technical Support: techsupport@n2power.com
805-583-7744 x119
Street Address: 130 West Cochran Street, Suite C
Simi Valley, CA 93065