



Product Specification

XL275-AC Series

275-Watt AC to DC

Power Supplies

705123 Rev 04-15-19

Notices

N2Power is a wholly owned subsidiary of Qualstar Corporation.

N2Power and the *N2Power* logo are registered trademarks of Qualstar Corporation.

Copyright© 2007-2014 by Qualstar Corporation — All Rights Reserved

For warranty information refer to www.n2power.com

Information contained in this document is copyrighted by Qualstar Corporation and is intended for use by customers and prospective customers to evaluate and integrate our power supplies. Customers and prospective customers may reproduce this document as needed for these purposes. Reproduction in whole or in part for any other purpose or by any other party is prohibited without prior written permission from Qualstar Corporation.

Every effort has been made to keep the information contained in this document current and accurate as of the date of publication or revision. However, no guarantee is given or implied that the document is error-free or that it is accurate with regard to any specification.

N2Power reserves the right to modify the design or specification without notice. This specification may not be construed as a contractual obligation except as specifically agreed to by *N2Power* in writing at the time of order.

For information about this product specification, please write or call *N2Power* at:

130-W Cochran St, Suite C
Simi Valley CA 93065

FAX: (805) 583-7749
Phone: (805) 583-7744

E-Mail: sales@n2power.com
www.qualstar.com/n2p-pss.php

Table of Contents

1. Introduction	1-1
1.1 Introduction	1-1
1.2 Digital Control	1-2
1.3 Agency Compliance	1-3
2. AC Input	2-1
2.1 Input Line Requirements	2-1
2.2 Input Over Current Protection	2-1
2.3 Inrush Current Limiting	2-1
2.4 Low Input Voltage	2-1
2.5 AC Leakage Current	2-2
2.6 Power Factor	2-2
2.7 IEC 61000-3-2 Harmonics	2-3
2.8 Safety Warning	2-3
3. DC Outputs	3-1
3.1 Output Voltage Regulation	3-1
3.2 Grounding	3-1
3.3 No-Load Operation	3-1
3.4 Voltage Trim	3-2
3.5 Output Current/Power	3-2
3.6 Efficiency	3-3
3.7 Unloaded Power Consumption	3-6
3.8 Cooling	3-6
3.9 Output Ripple/Noise	3-7
3.10 FAN Outputs	3-8
3.11 Local and Remote Sensing	3-8
3.12 Parallel Operation	3-9
3.13 Power Supply Protection	3-11
3.14 Fault Code Summary	3-13
3.15 Output Transients	3-14
3.16 Capacitive Loading	3-14

4.	General Specifications	4-1
4.1	Environmental	4-1
4.2	Mean Time Between Failures	4-1
4.3	Component Stress.....	4-1
4.4	Physical Dimensions.....	4-2
4.5	Labeling/Marking.....	4-2
4.6	Weight	4-3
4.7	Mating Connectors	4-3
4.8	Signal Descriptions and Remarks	4-6
5.	Timing and Control	5-1
5.1	Power Supply Timing.....	5-1
5.2	Power Good: Outputs and LED.....	5-1
5.3	Standby LED Output	5-2
5.4	AC LED.....	5-2
5.5	PS_ON Input.....	5-2
5.6	Voltage Hold-Up Time.....	5-2
5.7	Output Rise Time	5-3
5.8	Overshoot at Turn On/Turn Off.....	5-3
6.	Ordering Information	6-1
7.	Customization	7-1

1.

Introduction

1.1 Introduction

This specification defines the design and performance characteristics of an open frame single-phase (3 wire) universal input, power factor corrected, single output, 275-watt series of open frame switch mode power supplies. The twenty XL275 models listed in Table 3-1 provide output DC voltages between 12V and 56V. They are available with or without active current sharing (including built-in OR-ing MOSFET). Model numbers are defined as XL275-xx [CS] where xx is the main output voltage. Models with active current-sharing are indicated by the suffix “CS” following the model number.

Additionally, all models provide a +5 V_{standby} output (1.0A max.) whenever AC power is applied. A +12 V_{aux} output (1.0A max.) is also available on all models whenever the main output is on. This output is repeated on the FAN connector to provide for 10CFM of cooling airflow for the XL275. The main and +12 V_{aux} outputs may be disabled by opening the PS_ON/ input. These single-output models can be used as standalone power supplies or can be used in redundant or N+1 configurations with up to 4 units connected in parallel.



1.2 Digital Control

The XL275 uses a dedicated digital microcontroller to supervise its operation. Doing so greatly improves timing accuracy and eliminates stored charge delays found in analog control circuits. The microcontroller samples the following parameters 500 times per second and uses intelligent algorithms to act upon the constantly changing conditions.

- DC voltage on the bulk capacitor (supplied by the AC mains)
- Output Voltage
- Output Current
- Auxiliary 12V output voltage
- Transformer temperature
- Ambient temperature
- Fan tachometer

The microcontroller is responsible for enabling the main output whenever all of the required startup conditions are met and shutting it down upon command, loss of input power or whenever the power supply's longevity is threatened by excessive loads or temperatures. It will provide the host system with advanced warning of an impending shutdown whenever one of these conditions occurs.

To minimize acoustic noise, the microcontroller can turn a 12V fan on or off based upon the on XL275's ambient temperature (turn-on threshold is 45°C with turn-off at 40°C).

An optional PMBus digital communications interface is also available to allow up to four XL275s to communicate over the same PMBus. This communications interface allows routine remote control of the main outputs and the 12V fans. The host can also query the microcontroller for its output voltage and current as well as the ambient and transformer temperatures. It can also check for a fan failure (lost tachometer pulses). The PMBus option also allows for variable speed fan control based on XL275's ambient temperature. A PMBus User's Guide is available at www.n2power.com/documents.htm.

Because it's programmable, the microcontroller code can be customized to fit an OEM's requirements.

1.3 Agency Compliance

The XL275 complies with the following international agency standards:

Safety	Complies with Standard	Remarks
United States	UL 60950-1 Second Edition UL 62368-1 Second Edition (Information Technology Equipment)	Leakage Current – see table 2-2 Hi-pot – 2121vdc for 1 second
Canada	CAN/CSA-C22.2 No. 60950-1 (2007) Second Edition	
EU Council	2006/95/EC (August 2007)	Low Voltage Directive
International	IEC 60950-1 (2005) Second Edition IEC 62368-1 (2014) Second Edition	
China (CCC)	GB4943.1-2011	
Taiwan (BSMI)	CNS14336-1 (2010)	
EMC	Complies with Standard	Remarks
United States	FCC part 15, subpart B	Conducted emissions Limits per CISPR 22 Class B Tested to ANSI C63.4: 2003
EU Council	2004/108/EC	EMC Directive
International	EN 61204-3 (refers to the following) EN 55022 Class B EN 55024 (refers to the following) EN 61000-3-2 Class D EN 61000-3-3 EN 61000-4-3 EN 61000-4-4 EN 61000-4-5 EN 61000-4-6 EN 61000-4-11	Low Voltage Power Supplies – DC Output Conducted emissions Limits per CISPR 22 Class B Immunity Harmonic Current Emissions (Power Factor Correction – PFC) Voltage Fluctuations & Flicker Radiated Susceptibility Fast Transient/Burst Immunity Power Mains Surge Immunity RF Immunity Voltage Dips, Short Interruptions
Reduction of Hazardous Substances (RoHS)	Complies with Standard	Remarks
EU Council	2002/95/EC 2011/65/EU	RoHS Directive RoHS 2 Directive

Continued below.

Marks of Conformance

United States & Canada  (Underwriters Laboratories File E211115)

China  *selected models only.

 *Only associated with the CCC mark.
Only used at altitude not exceeding 2000M. ←

 *Only associated with the CCC mark.
Only used in non-tropical climate regions.

Taiwan  *selected models only.

EU Council 

RoHS  

← The XL275 models are approved for operation at an altitude of 5,000 meters.

Table 1-1 Agency Compliance

2.

AC Input

2.1 Input Line Requirements

The following table defines the voltage and frequency requirements for the AC line inputs to the XL275 series. The XL275 is capable of supplying full rated power in continuous operation throughout the specified ranges of voltages and frequencies. The power supply will automatically recover from AC power loss and is capable of starting under maximum load at the minimum AC input voltage described below.

Parameter	Minimum	Rated	Maximum
RMS Input Voltage	90 VAC	100–240 VAC	264 VAC
RMS Input Current	–	–	3.6 A @ 100 V 1.5 A @ 240 V
Input Frequency	47 Hz	50–60 Hz	63 Hz

Table 2-1 XL275 AC Input Parameters

2.2 Input Over Current Protection

The XL275 series incorporates a primary AC line fuse for input over current protection to prevent damage to the power supply and meet product safety requirements as outlined in Section 1.3.

2.3 Inrush Current Limiting

The cold-start inrush current is limited to 13-amps peak at 240 VAC input voltage (see Table 2-1) and 6.5-amps peak at 120 VAC @ 25C. Repetitive ON/OFF cycling of the AC input voltage should not damage the power supply or cause the input fuse to fail as long as the power remains off for two or more seconds.

2.4 Low Input Voltage

The application of an input voltage below the minimums specified in Table 2-1 shall not damage the XL275.

2.5 AC Leakage Current

The leakage current from AC line or AC Neutral inputs to Protective Earth varies linearly with the input voltage and frequency (see operating column of Table 2-2). When multiple power supplies are used, their leakage currents are additive. Consult the appropriate electrical safety specification for the maximum leakage current permitted in your product. The leakage current will always go to zero when a DPDT switch simultaneously disconnects both the line and neutral circuits. A single fault can occur when the AC power is applied to only the Neutral input terminal.

Line Voltage Frequency	Operating	Single Fault (see text)
120VAC, 60Hz	0.32 mA	0.48 mA
240VAC, 60Hz	0.64 mA	0.94 mA
240VAC, 50Hz	0.54 mA	0.79 mA

Table 2-2 AC Leakage Current – Single XL275

2.6 Power Factor

The XL275's input power factor exceeds 0.97 with total loading of 220-watts (80%) or greater at any specified input voltage and frequency. For lower loads at 230VAC, use the following graph to obtain the approximate power factor.

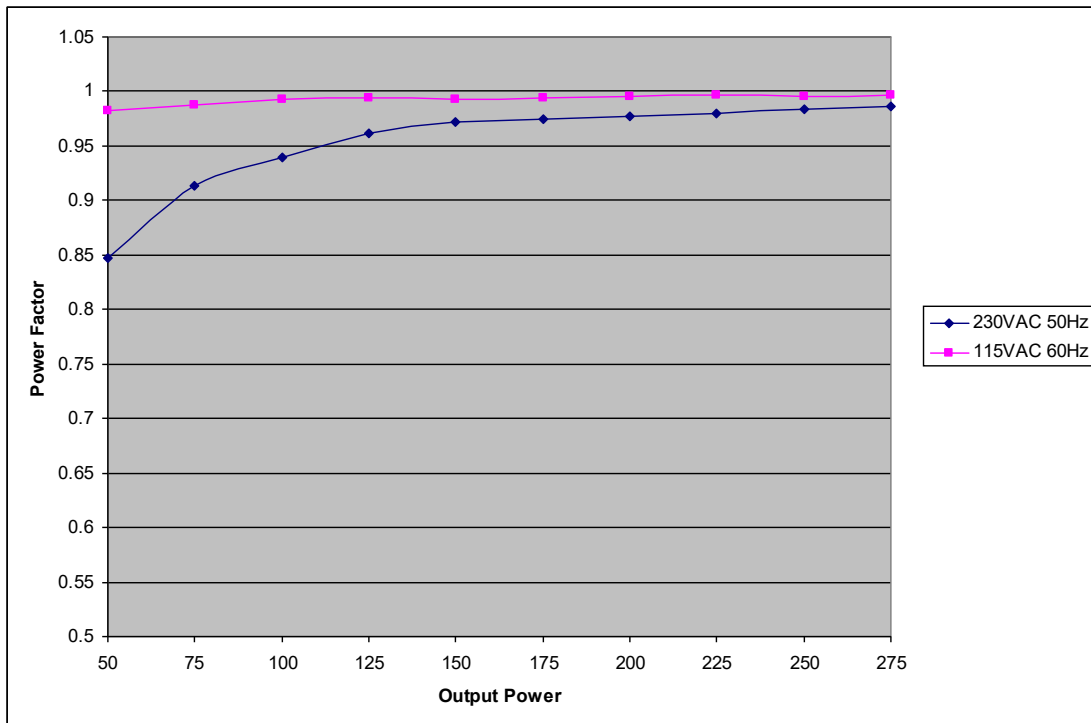

Figure 2-1 Power Factor, Typical

2.7 IEC 61000-3-2 Harmonics

The XL275 complies with Class D of this international standard at 230VAC/50Hz with loads of 50-watts or higher.

2.8 Safety Warning

WARNING

The XL275 is a component, not a stand-alone power supply. It must be mounted inside a protective enclosure to prevent accidental shock by contact with the supply. Lethal voltages are present while and after AC power is applied to the XL275. Allow 1-minute for storage capacitors to discharge after removing AC power before handling the XL275.

The safety ground connection is the chassis itself and it must be connected to Protective Earth.

3.

DC Outputs

3.1 Output Voltage Regulation

The DC output voltages shall remain within the minimum and maximum limits of Table 3-1 when measured at the power supply connector under all specified line and environmental conditions contained herein. The regulation accuracy is measured between a 10-watt load and the maximum load currents listed in Table 3-3.

Model	Out-put	Rated Voltage	Regulation	Minimum (VDC)	Nominal (VDC)	Maximum (VDC)	Remote Sense
XL275-12 [CS]	V1	+12 V	±3%	11.64	12.00	12.36	V1/RTN
XL275-15 [CS]	V1	+15 V	±3%	14.55	15.00	15.45	V1/RTN
XL275-16 [CS]	V1	+16 V	±3%	15.52	16.00	16.48	V1/RTN
XL275-18 [CS]	V1	+18 V	±3%	17.46	18.00	18.54	V1/RTN
XL275-24 [CS]	V1	+24 V	±3%	23.28	24.00	24.72	V1/RTN
XL275-28 [CS]	V1	+28 V	±3%	27.16	28.00	28.84	V1/RTN
XL275-36 [CS]	V1	+36 V	±3%	34.92	36.00	37.08	V1/RTN
XL275-48 [CS]	V1	+48 V	±3%	46.56	48.00	49.44	V1/RTN
XL275-54 [CS]	V1	+54 V	±3%	52.38	54.00	55.62	V1/RTN
XL275-56 [CS]	V1	+56 V	±3%	54.32	56.00	57.68	V1/RTN
All Models	V2	+12 V _{aux}	±5%	11.0	11.6	12.2	None
	V3	+5 V _{stby}	±5%	4.75	5.00	5.25	None

Table 3-1 XL275 Output Voltage Specifications

3.2 Grounding

All DC outputs, status outputs and control inputs share a common DC Return found on all output connectors. DC Return floats from the chassis (Protective Earth) with a 4700pF, 250VAC capacitor between them.

3.3 No-Load Operation

A no-load condition will not damage the supply or cause a hazardous condition. The power supply will remain stable and operate normally after application of a load. The output voltage regulation may diminish to ±5%. The Power Good logic output will indicate normal operation when the supply is unloaded. The power-factor does not meet its specification under no-load conditions.

3.4 Voltage Trim

The voltage trim input pin is provided to allow the user to adjust the V1 output up or down by up to 5%. If voltage trim is not required, the TRIM input should be left unconnected. Connecting a resistor between this pin and DC Return will increase the output voltage while connecting a resistor between this pin and the V1 output will decrease the output voltage. The ability of the V1 output to maintain its specified regulation accuracy under severe load or line conditions could be diminished by trimming the output to a higher than nominal voltage.

For trimming the V1 output voltage upwards, connect the TRIM resistor between the TRIM pin and DC Return. The TRIM resistor value is approximately equal to:

$$R_t = (101,732 / \langle \text{percentage change} \rangle) - 15,800 \quad (\text{where percentage} = 2.5 \text{ for a } 2.5\% \text{ change})$$

For trimming the V1 output voltage downwards, connect the TRIM resistor between the TRIM pin and V1 output. The TRIM resistor value is approximately equal to:

$$R_t = (V1_{\text{out}} - 2.525) / (\langle \text{percentage change} \rangle * 2.482E-5) - 15,800$$

Model	V1 Up 3%	V1 Down 3%
XL275-12 [CS]	18.1K	111K
XL275-24 [CS]	18.1K	272K
XL275-48 [CS]	18.1K	594K
XL275-56 [CS]	18.1K	702K
Connect Trim Resistor between TRIM pin J3-1 and:	DC Return pin J3-3	V1 Output pin J2-1

Table 3-2 Trim Resistors Examples

When two or more XL275's are operating in parallel, each unit should be trimmed with the same resistor value. The TRIM input is connected through a 15.8K resistor to the voltage control loop input of the XL275 and should never be connected to anything but a resistor mounted as close as possible to J3. Long wiring to a trim resistor can pickup noise and could find its way to the output terminals. Do not connect the TRIM inputs from multiple supplies together.

3.5 Output Current/Power

The maximum available output power is always a function of the cooling airflow and its temperature. The maximum of 275-watts combined total power from all outputs is only available with a minimum of 10-CFM of effective forced air-cooling at no more than 50°C. The Maximum Loads listed in Table 3-3 assume no-load on the V2 and V3 outputs. Reduce the maximum V1 load watt-for-watt when adding V2 or V3 loads.

Model	Out-put	Rated Voltage	Maximum Load (A)	Current Sense A/V
XL275-12 [CS]	V1	+12 V	22.92	11.35
XL275-15 [CS]	V1	+15 V	18.33	9.07
XL275-16 [CS]	V1	+16 V	17.19	8.51
XL275-18 [CS]	V1	+18 V	15.78	7.81
XL275-24 [CS]	V1	+24 V	11.46	5.67
XL275-28 [CS]	V1	+28 V	9.82	4.86
XL275-36 [CS]	V1	+36 V	7.64	3.78
XL275-48 [CS]	V1	+48 V	5.73	2.84
XL275-54 [CS]	V1	+54 V	5.09	2.52
XL275-56 [CS]	V1	+56 V	4.91	2.43
All Models	V2	+12 V _{aux}	1.0	N/A
	V3	+5 V _{stby}	1.0	N/A

Table 3-3 Maximum Individual Load Currents (sum limited to 275W)

The V1 output current can be easily measured on the V1 Current Share pin (Section 4.8). This positive DC output indicates the approximate output current of a single supply or of each supply when current sharing parallel units. Do not load this output with any capacitance and use a DC voltmeter for measurement. See Table 3-3 above for output scaling. Too much capacitance is present if the V1 output voltage increases when making the above measurement.

3.6 Efficiency

The power supply efficiency varies with the output load and the line voltage. The following graphs show the efficiency of the main output with an effective 10-CFM of cooling air at 25°C after a 15-minute warm-up period. The +5 V_{standby} and +12 V_{aux} outputs were unloaded. Higher output voltage models are slightly more efficient. Only four models are shown below; use the curve with the closest output the desired output voltage. The efficiency of active current sharing models is reduced by less than 0.5% at full-load (even when operating solo). These curves are based on a typical power supply and will vary slightly in production.

XL275-12 Efficiency vs. Output Power

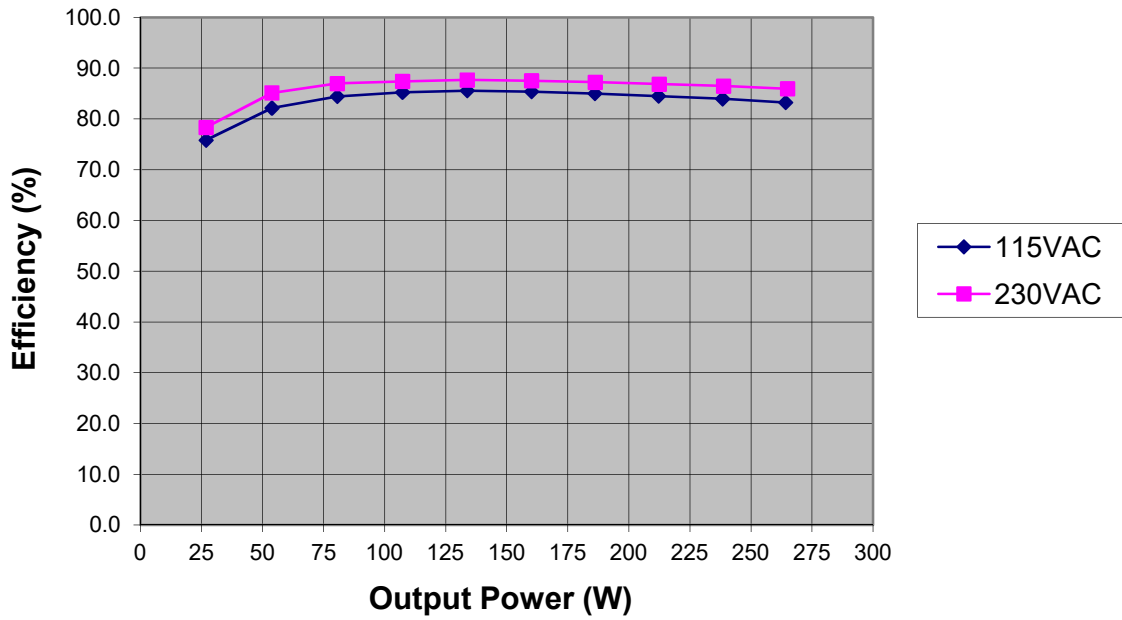

Figure 3-1 XL275-12 Efficiency

XL275-24 Efficiency vs. Output Power

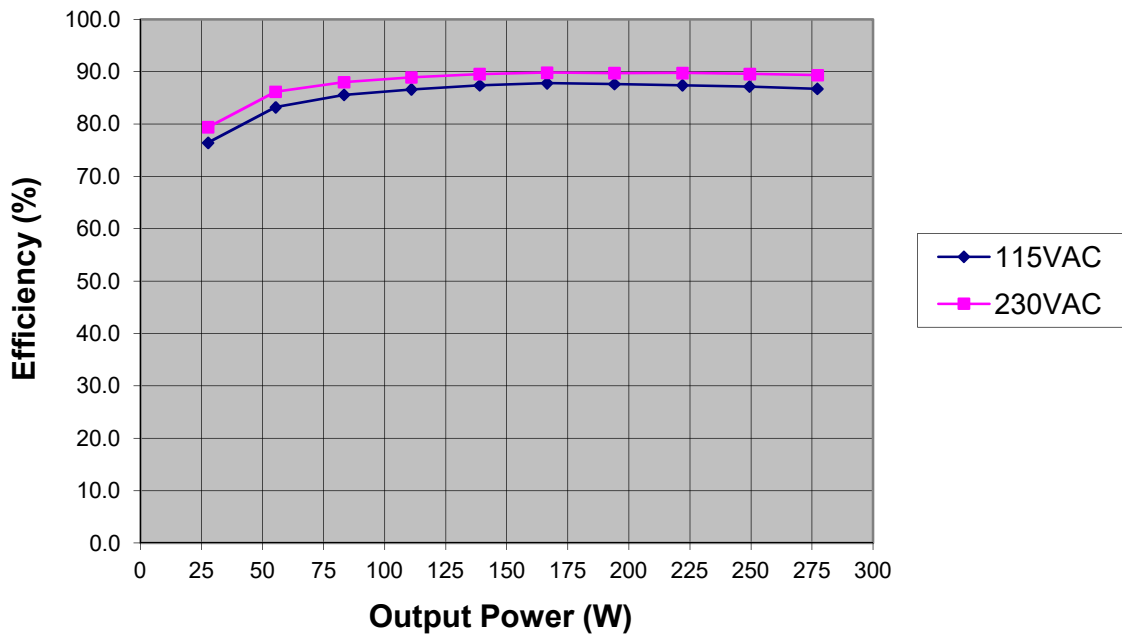

Figure 3-2 XL275-24 Efficiency

XL275-48 Efficiency vs. Output Power

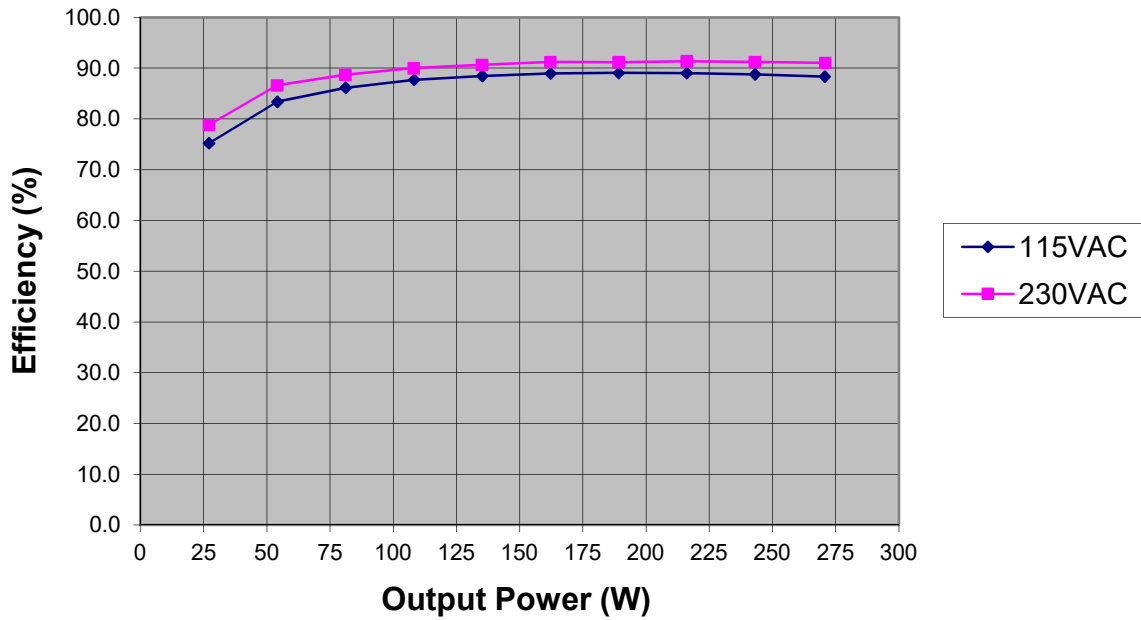

Figure 3-3 XL275-48 Efficiency

XL275-56 Efficiency vs. Output Power

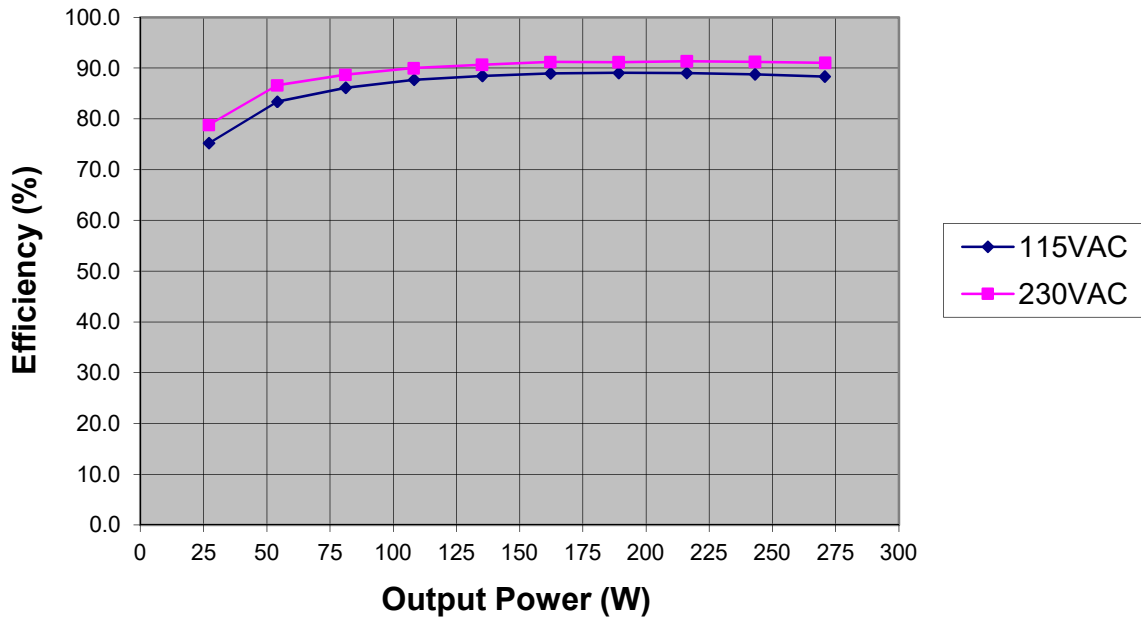

Figure 3-4 XL275-56 Efficiency

3.7 Unloaded Power Consumption

When completely unloaded and at any normal input voltage, the XL275 consumes about 3-watts with a high PS_ON input (standby state) and about 7-watts with a low PS_ON input (V1 & V2 on but unloaded). The power-factor does not meet its specification under these conditions.

3.8 Cooling

The XL275 power supplies can operate with convection cooling at temperatures below 50°C when total power output is less than 150-watts and they are mounted open side up with adequate space for their heat to rise. 10-CFM of forced-air cooling at a maximum of 50°C is required when the output power exceeds 150-watts. The cooling airflow must be either co-planar with the circuit board or it must impinge downward in the center of the open topside. The XL275 may be mounted in any attitude when forced-air cooled.

3.8.1 Output Power Derating at Elevated Temperatures

The XL275 can be operated with cooling air temperatures above 50°C by linearly derating the total maximum output power (or current) by 2.5%/°C from 50°C to 70°C (see Figure 3-5).

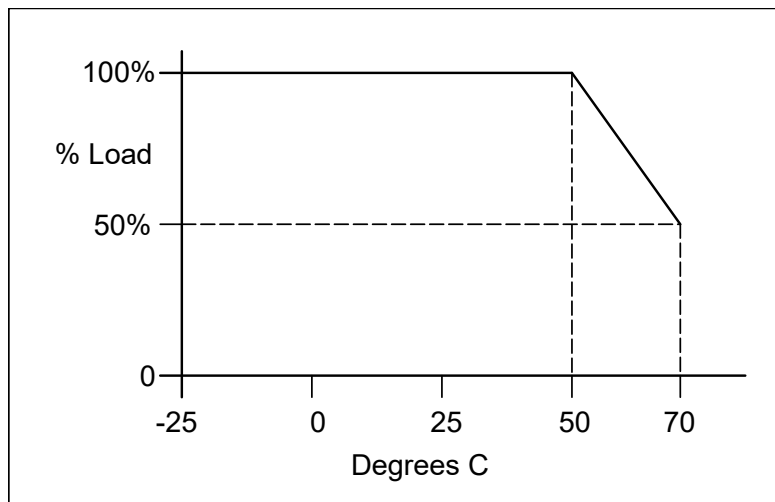

Figure 3-5 XL275 Output Power vs. Ambient Temperature Envelope

3.8.2 Over-Temperature Shutdown

The power supply is equipped with internal temperature sensors. Failure to provide adequate cooling airflow below the maximum operating temperature will result in the power supply shutting down the V1 and V2 (+12Vaux) outputs while the V3 (+5Vstandby) output will remain operational. See Section 3.13.1 for details.

3.9 Output Ripple/Noise

Output ripple voltage and noise are defined as periodic or random signals over a frequency band of 10 Hz to 20 MHz. Measurements are to be made with an oscilloscope with a 20 MHz bandwidth. Outputs should be bypassed at the connector with a 0.1 μ F ceramic disk capacitor and a 10 μ F tantalum capacitor to simulate system loading (see Figure 3-6). Ripple and noise shall not exceed the limits specified in the following tables.

The ripple voltage of the output is measured at the pins of the mating connector. Ripple and noise shall not exceed the limits specified in Table 3-4 under any condition of line voltage and frequency specified in Section 2.1 and DC loading specified in Section 3.5.

Model	Output	Maximum Ripple+Noise (peak-to-peak)
XL275-12 [CS]	V1 (main)	100 mV
XL275-15, -16 [CS]	V1 (main)	150 mV
XL275-18...56 [CS]	V1 (main)	200 mV
All	V2 (+12 V _{aux})	80 mV
All	V3 (+5 V _{standby})	50 mV

Table 3-4 Ripple + Noise Output Voltage

3.9.1 Ripple/Noise Test Setup

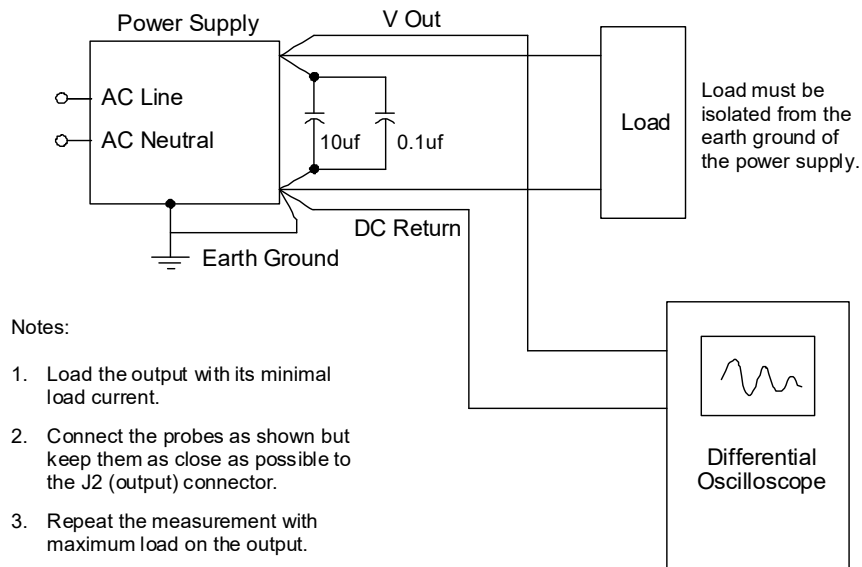

Figure 3-6 Ripple Noise Measurement Setup

3.10 FAN Outputs

There are two outputs for 12VDC fans derived from the +12 Vaux output. The total +12 Vaux is limited to 1.0A J4 is a 2-pin header dedicated to driving a fan. This 11.6V output (FAN) remains on as long as V1 is enabled and the total V2 load current is does not exceed 1.0A. This output may be wired in parallel with the same output on other XL275s to provide a redundant 1.0A source of fan power.

The second fan output (FAN2) appears on J6 pin-10. This 11.6V output is limited to 1.0A less any current being drawing from J4 & J3 pin-6 and is not energized until the ambient temperature exceeds 45°C or the output transformer (T2) temperature exceeds 100°C. The output is disabled when the temperatures both drop below 40°C and 90°C respectively. The PMBus option provides for a variable-speed FAN2 output at J6 pin-10.

The FAN2 output must not be connected to any other outputs from this or any other power supply. The FAN and FAN2 outputs may be simultaneously loaded as long as the sum of their currents and that of the +12 Vaux output on J3 pin-6 does not exceed 1.0A.

3.11 Local and Remote Sensing

Remote sensing is provided to compensate for voltage drops in the V1+Output and the DC RETURN wiring to the V1 load. The voltage at the remote sense inputs must never be allowed to differ by more than 0.5-volts from their respective output and return pins. If the Remote Sense inputs are left open, the output voltage at the J2 terminals will still meet the load regulation specification.

Remote sense lines can be extended through bulkhead connectors and right to the critical load within a user's system. Unplugging the remote sense lines simply causes a droop in the voltage at the load. Connecting the remote sense lines lifts the voltage at the load to within the regulation specification but may increase the V1 voltage at J2 above the regulation limits. See Figure Figure 3-7. Power output is always determined by the output voltage at J2, not at the load.

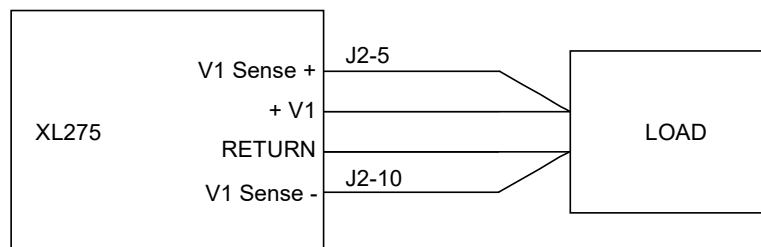

Figure 3-7 Remote Sense Wiring

3.12 Parallel Operation

The V1 output of two, three or four XL275-xx CS (with active current sharing) power supplies may be connected in parallel to provide higher V1 output power. They can also be used in an N+1 configuration to provide higher output power and greater reliability. Each CS model has a built-in output OR-ing diode (actively switched MOSFET) and a single-wire current share signal for parallel V1 operation. Remote sensing may still be used in parallel operation.

XL275s running in parallel are capable of starting with a total load that exceeds the capability of an individual unit, however, the rising output waveform may not be monotonic. They are also fully compatible with hot swapping and will tolerate the dramatic load fluctuations encountered in an N+1 redundant configuration when supplies are removed and replaced. Because of the inherent limitations of current sharing, it is recommended that the total load not exceed 92%-94% of the sum of the rated outputs (see Table 3-5). Assuming all XL275 output power is dedicated to the main output (no +12 Vaux +5 Vstandby use), the following table lists possible total system output power.

Number of XL275s	N Configuration	N+1 Configuration
1	275 watts	N/A
2	520 watts	275 watts
3	770 watts	520 watts
4	1015 watts	770 watts

Table 3-5 Total Output Power in N and N+1 Configurations

3.12.1 Current Sharing Connections

Current sharing requires like XL275-xx CS models where xx is the V1 output voltage. The V1 Current Share signal (see Table 4-9) of all supplies operating in parallel must be connected together. The output voltage of multiple power supplies in parallel is generally slightly higher than that of the supply with the highest stand-alone output voltage. See Figure 3-8 for an example of wiring two XL275's in parallel. Three and four supplies would be wired in a like manner with all four V1 Current Share signals tied together.

With active current sharing systems, the current share signal is a high-impedance analog output/input on each supply. This signal is quite susceptible to noise pickup and care must be used in wiring the Current Share signals of multiple supplies together. Any external capacitance on this signal will cause the output voltages of all supplies to rise and will compromise sharing accuracy. Do not connect any capacitance to this signal.

It is recommended that a twisted pair of wires be used to daisy-chain the V1 Current Share signal and its adjacent DC Return between each unit. See Table 4-9 for pinout information. Current sharing accuracy can be further enhanced by placing a 3.9K ohm resistor (+/- 10%) across the twisted-pair at only one point for the entire group of XL275s. Loop the Current Share twisted pair through a ferrite toroidal or split core at each XL275 to reap further sharing and output voltage accuracy.

When a single supply is used (non-sharing), the V1 Current Share pin should be disconnected. If this is not possible, then the same low-noise precautions listed above should be followed. Any wire connected to the Current Share pin will act as an antenna and pick up impulse noise created by the power supply. This can increase the main output voltage by as much as 10%. Use a twisted pair for improved immunity and add a 3.9K resistor between the V1 Current Share pin and a DC Return pin of J3 (typically between J3 pins 3 and 4). A quarter-watt resistor can be crimped with the wires into the J3 mating contacts and then covered with shrink tubing.

The current sharing signal is referenced to the same DC Return as the V1 output. It is imperative that the ground wiring from the load to each shared supply be of equal length and have the lowest possible resistance. This means four individual 18 AWG wires should be run from J2 (pins 6-9) of each supply to a star ground terminal or ground plane at the load.

Measure the DC voltage between J3 pin 5 of each supply while operating under full load. This is the DC Return signal and worst case difference should be less than 10mVDC. Measure the current share DC voltage from J3-4 to J3-5 of any supply. The value of the worst case difference in DC Return voltages divided by the normal current share voltage should be considered an error value. If the current share voltage is 1V and the DC Returns differ by as much as 100mV, this creates an additional 10% error ($.1/1 = 10\%$) that detracts from the current sharing accuracy.

Power Good signals must not be wire ORed together. Each individual Power Good signal should be monitored separately by the user's system.

3.12.2 Current Share Accuracy

When all the current share signals are connected together and all the Remote Sense signals are connected together, the load delivered by any two of the sharing supplies will not vary by more than 5% at full load. The sharing accuracy decreases with lower loads and with poor grounding techniques (see Section 3.12.1).

3.12.3 +5 V_{standby} Parallel Operation

The +5 V_{standby} output has a series Schottky rectifier just before the output connector that allows this output to be connected in parallel with the same output on like supplies. By doing so, the +5 V_{standby} output will remain alive as long as one of the paralleled supplies is functioning. The output current rating does not increase beyond the single supply rating.

3.12.4 +12 V_{aux} Parallel Operation

The +12 V_{aux} output has a series Schottky rectifier just before the output connector that allows this output to be connected in parallel with the same output on like supplies. By doing so, the +12 V_{aux} output will remain alive as long as one of the paralleled supplies is functioning. The output current rating does not increase beyond the single supply rating and the net output voltage is closer to 11.6V than 12V.

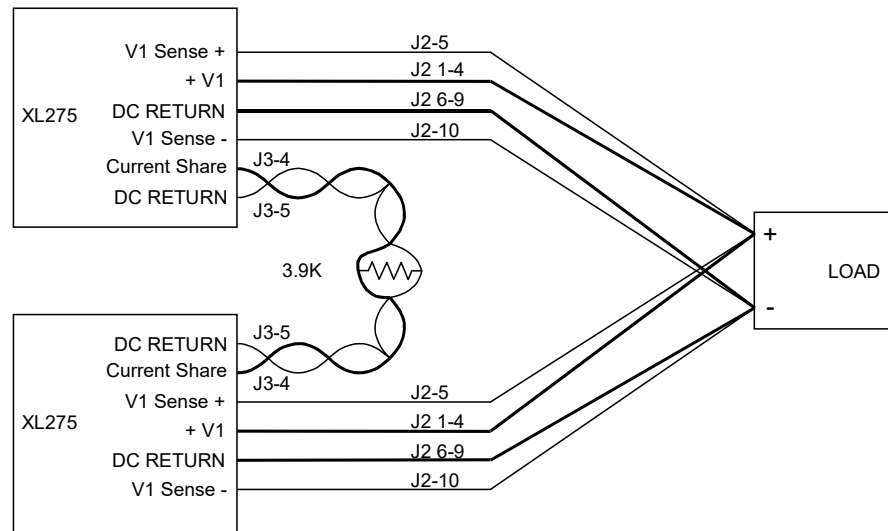

Figure 3-8 Current Sharing Wiring Example

3.12.5 Transients

The output rise time and monotonic requirements of Section 5.7 may not be met when the load exceeds 275-watts, because of the difference in start-up times of the paralleled power supplies.

When the AC line to one of the parallel power supplies is disconnected or reconnected, or a power supply fails, the transient on the V1 output is within 6% of nominal output voltage. The output voltage may ramp to a new nominal voltage within the regulation band after a configuration change.

3.13 Power Supply Protection

There are several different protection circuits designed to protect the load and the XL275 from component failures and extraordinary circumstances.

3.13.1 Over Temperature Protection

If the XL275 is operated without adequate cooling, it will sense an over-temperature condition and shut down the V1 (main) and V2 (+12Vaux) outputs 2mS after dropping the Power Good signal. There are two possible over-temperature conditions: an ambient temperature in excess of approximately 90°C or the main transformer temperature in excess of approximately 120°C. Excessive transformer temperature can be caused by inadequate cooling or excessive combined output power of V1 and V2. The V1 and V2 outputs will be automatically restored when the temperature of the built-in temperature sensors cool to 110°C and 80°C or below respectively.

3.13.2 Over-Voltage Protection

Over-voltage protection is only provided on the V1 output. When an over-voltage condition occurs, the power supply will shut down and will not restart until AC power is

turned off and back on (off for 5-seconds minimum) or the PS_ON/ signal is cycled off for 25mS or longer and then back on.

The XL275 will shut down under the V1 output reaches the following percentages of the nominal output voltage:

Over-Voltage Protection Threshold		
Minimum	Nominal	Maximum
116%	120%	124%

Table 3-6 Over-Voltage Protection Limits

3.13.3 Under-Voltage Protection

The Power Good signal goes false whenever the V1 output voltage falls below 90% of nominal value for 4mS or more. The Power Good signal will be automatically restored if the output rises above 93% of the nominal for 4mS.

An under-voltage fault occurs whenever the V1 output voltage falls below 80% of nominal for more than 30mS. In this case, the V1 and V2 outputs are immediately disabled and the Power Good status is set false. This off condition will remain until AC power is turned off and back on (off for 5-seconds minimum) or the PS_ON/ signal is cycled off for 25mS or longer and then back on.

Under-Voltage Protection Thresholds		
PG falls	PG Recovers	Shutdown
90%	93%	80%

Table 3-7 Nominal Under-Voltage Protection Thresholds

3.13.4 Short-Circuit and Over-Current Protection

V1 load currents in excess of 120% of the rated output lasting more than 10-milliseconds will cause only the V1 and V2 outputs to shut down. This feature is tested with an ever-increasing load at a rate of 10 A/second starting at the maximum rated load current.

Steady-state loads below 93% with pulses of up to 150% for less than 10-milliseconds will be tolerated providing the duty-cycle does not exceed 10%. The total RMS output power (of all three outputs) must still be limited to 275-watts as in this example.

After shutting down from overload, the XL275 automatically attempts to restart itself every four-seconds for up to 5-minutes. It will succeed if the V1 load is reduced below the XL275's maximum rated load. Restart attempts will cease after unsuccessfully trying to restart for 5-minutes, whereupon the AC power must be recycled to recover.

An overload on the +12Vaux output will not cause V2 to shut down and will resume normal operation after the short circuit is removed. An overload on the +5 Vstandby output will completely disable the power supply, but it will recover after the overload is removed.

3.13.5 Over-Power Protection

In addition to the over-current and short-circuit protection listed above, the XL275 will limit its instantaneous output power (pulses less than 10mS in duration) to approximately 520-watts (exclusive of the energy stored in the output capacitors and the 5V Standby power). Exceeding this limit will not damage the power supply and may result in an under-voltage fault code (see below). AC power must be recycled to recover from an under-voltage fault.

Model	Output Capacitance	Stored Energy
XL275-12 [CS]	2,040 μ F	0.147 Joules
XL275-15 [CS]	1410 μ F	0.159 Joules
XL275-16 [CS]	1410 μ F	0.180 Joules
XL275-18 [CS]	1410 μ F	0.228 Joules
XL275-24 [CS]	990 μ F	0.285 Joules
XL275-28 [CS]	990 μ F	0.388 Joules
XL275-36 [CS]	540 μ F	0.350 Joules
XL275-48 [CS]	450 μ F	0.518 Joules
XL275-54 [CS]	450 μ F	0.656 Joules
XL275-56 [CS]	450 μ F	0.706 Joules

Table 3-8 V1 Nominal Internal Output Capacitance & Stored Energy

3.14 Fault Code Summary

The XL275 utilizes a microcontroller to supervise its operation. It is powered by V3 (5V Standby) and is not affected by V1 and V2 output faults. It will enable and disable the V1 and V2 output voltages in response to requests on the PS_ON/ input and also provides the Power Good, Power Good LED and Standby LED outputs.

The microcontroller also measures the V1 output voltage and output current in addition to the ambient and main output transformer temperatures. It will shut the V1 (main) and V2 (12V Aux) outputs off whenever an abnormal condition occurs that could potentially damage the load or the power supply.

When the microcontroller disables the V1 and V2 output voltages, it blinks an alarm code on the green Power Good LED (located behind J6) and on an optional external Standby LED. A Long blink illuminates the Standby LED while it darkens the Power Good LED for 1000mS. A short blink lasts only 300mS. There is a 100mS pause between blinks and a 2000mS pause before repeating a fault code.

Fault Condition	Ends when...	Blink* Code
Under-voltage	AC power is recycled or PS_ON/ is recycled	5-Short
Over-voltage	AC power is recycled or PS_ON/ is recycled	4-Short
Short-circuit	Attempts to restart every four seconds for up to 5-minutes	3-Short
Over-current	Attempts to restart every four seconds for up to 5-minutes	2-Short
Transformer Over-temperature	XL275 cools down	Long-Short
Ambient Over-temperature	XL275 cools down	Short-Long

*Power Good LED located behind J6 blinks off (dark)

*Optional external Standby LED blinks on (light)

Table 3-9 Fault Code Summary

Utilizing an external Standby LED allows a user to see any fault codes on the front panel of the equipment.

3.15 Output Transients

The maximum output voltage transient caused by step load changes will not exceed the output voltage regulation limits by more than 5%. With an AC input as specified in Section 2.1, the power supply will remain stable when subjected to the load transients described below with capacitive loading per Table 3-10:

- Load changes between 75% and 100% on any output
- Load changing repetition of 50 to 333 cycles per second
- Transient load slew rate = 1.0 A/microsecond

3.16 Capacitive Loading

The XL275 will startup and operate normally with external load capacitance on the V1 output that does not exceed those listed in Table 3-10. For models not listed below, choose the next lowest output voltage.

Output	XL275-12 [CS]	XL275-24 [CS]	XL275-48 [CS]	XL275-56 [CS]
V1 load	4,000 μ F	2,000 μ F	500 μ F	350 μ F
V2 (+12 V _{aux})	350 μ F	350 μ F	350 μ F	350 μ F
V3 (+5 V _{standby})	200 μ F	200 μ F	200 μ F	200 μ F

Table 3-10 XL275 Capacitive Loading

4.

General Specifications

4.1 Environmental

The XL275 meets or exceeds the following environmental specifications:

Parameter	Conditions	Specification	Remarks
Temperature	Operating	-25°C to 50°C	See cooling requirements
	Non-Operating	-40°C to 85°C	
Relative Humidity	Operating	95% Maximum	Non-Condensing
	Non-Operating	95% Maximum	Non-Condensing
Altitude	Operating	16,404 feet MSL Max.	5,000 meters
	Non-Operating	50,000 feet MSL Max.	15,240 meters
Vibration	No damage	2.4G RMS Maximum	5-500Hz, 10-min. each axis per MIL-PRF-28800F: 3.8.4.1 (Class 3,4)
Mechanical Shock	No damage	30G half-sine, 11mS	Six shocks each axis per MIL-PRF-28800F: 4.5.5.4.1

Table 4-1 Environmental Specifications

4.2 Mean Time Between Failures

The calculated MTBF of the power supply is equal to or greater than 645,000 hours of continuous operation at maximum output loading and worst case input line voltage with forced-air cooling at 25°C. N2Power does not warrant the MTBF to be representative of any particular unit. The MTBF of the power supply is calculated with an 80% confidence level in accordance with Bellcore, SR-332, Issue 2. Actual failure rates vary from unit to unit.

4.3 Component Stress

The XL275 was designed with the following component-derating guidelines at an operating ambient temperature of 50°C: semiconductor junction temperatures shall not exceed ninety (90) percent of manufacturer's rating. Inductor winding temperatures shall not exceed safety agency requirements. Electrolytic capacitor case temperatures shall not exceed 95% of rated temperature. Resistor power dissipation shall not exceed 70% of rated while other components will not be operated at more than 90% of their rated voltage or current.

4.4 Physical Dimensions

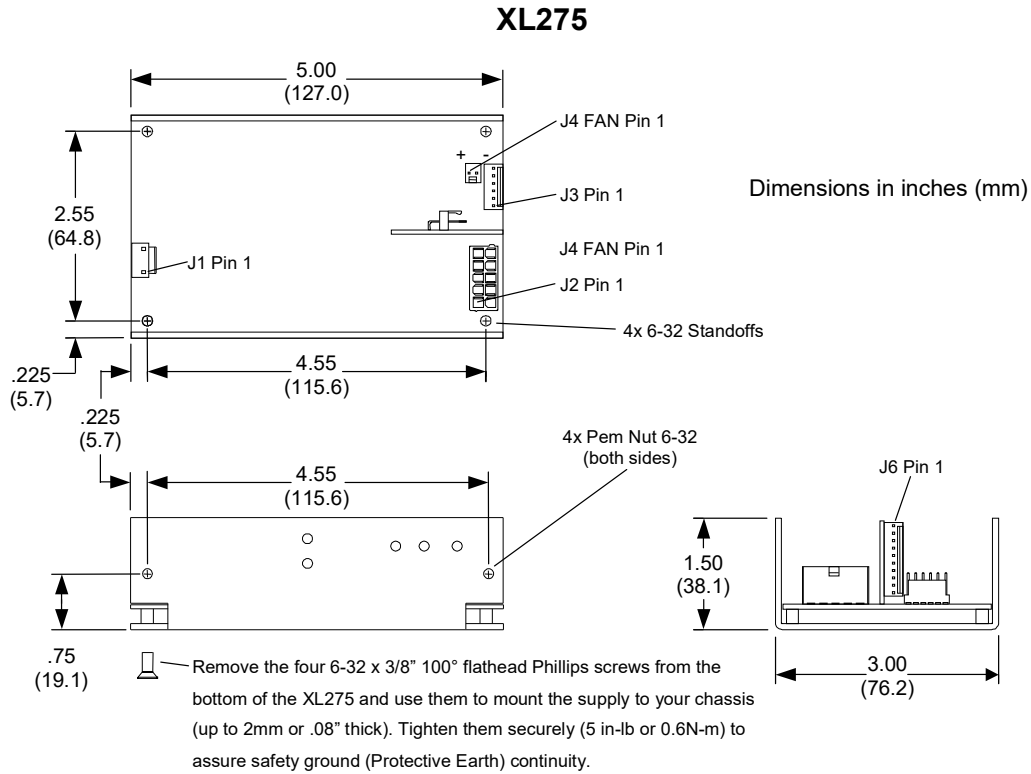

Figure 4-1 XL275 Dimensions

4.5 Labeling/Marking

The power supply is marked and labeled with the N2Power logo, model number, part number, input and output specifications, production code, appropriate safety agency logos, CE mark, and country of origin. A typical label is pictured below. Legacy model numbers are shown in parenthesis when applicable.



Figure 4-2 Sample XL275 Label

4.6 Weight

Units	Net Weight
Pounds	1.0
Ounces	16
Kilograms	0.45

Table 4-2 XL275 Net Weight of a Single XL275

4.7 Mating Connectors

The user must furnish all mating connectors. The mating connectors must meet the requirements of all applicable safety agencies (notably UL). Molex™ (Molex is a trademark of the Molex Corporation) did not change their part numbers when they took the lead out of their contacts. The Molex part numbers in this section should yield RoHS compliant contacts. The largest wire size accepted by each contact should be used for all power connections to help dissipate the heat generated by the resistive connections.

Note that the female contacts that mate to the power supply are only rated for 25-30 mating cycles. Excessive mating cycles causes dramatically increased terminal resistance and heating resulting in the eventual failure of the mating terminal and possibly the header on the power supply.

CAUTION

The pin-1 location differs amongst connector manufacturers. Sometimes pin-1 differs between the header (on the power supply) and the mating housing from the same manufacturer. Disregard the manufacturer's pin-1 location and follow only the pin-1 locations in Figure 4-1.

4.7.1 AC Input Mating Connector J1

The AC input connector to the XL275 is a 3-pin Molex KK style header with 0.156" centers. The center pin is omitted to provide adequate insulation spacing. The Molex part numbers for the mating housing and crimp-style snap-in terminals are listed below. There may be equivalent connectors available from other manufacturers. AWG 18 wire is recommended.

J1	Molex P/N
Connector Circuits (pins)	2 of 3
Mating Housing	09-50-8031
Rated Contact Current	7.0 A
Crimp Terminal (tin)	08-50-0106
Rated Wire Size	AWG 18 or 20

Table 4-3 J1 Mating Connector

4.7.2 DC Output Connector J2

The DC output connector is a Molex Mini-Fit, Jr.® header with 0.165” centers. The Molex part numbers for the mating housing and crimp-style snap-in terminals are listed below. There may be equivalent connectors available from other manufacturers. AWG 16 wire with the 39-00-0078 contact is recommended.

J2	Molex P/N	Rated AWG
Connector Circuits (pins)	10	
Mating Housing	39-01-2100	
Rated Contact Current	9.0 A	16
Recommended Crimp Terminal	39-00-0078	16
Alternate Crimp Terminal	39-00-0039	18-24

Table 4-4 J2 Mating Connector

4.7.3 Auxiliary Connector J3

The auxiliary connector on the XL275 is a Molex KK header with 0.100” centers. The Molex part numbers for the mating housing and crimp-style snap-in terminals are listed below. There may be equivalent connectors available from other manufacturers.

J3	Molex P/N
Connector Circuits (pins)	6
Mating Housing with ramps & ribs	22-01-3067
Crimp terminal (selective gold)	08-65-0816
Rated Contact Current	2.5 A
Rated Wire Size	AWG 22 thru 30

Table 4-5 J3 Mating Connector

4.7.4 FAN Connector J4

The FAN connector on the XL275 is a Molex KK header with 0.100" centers. The Molex part numbers for the mating housing and crimp-style snap-in terminals are listed below. There may be equivalent connectors available from other manufacturers.

J4	Molex P/N
Connector Circuits (pins)	2
Mating Housing with ramps & ribs	22-01-3027
Crimp terminal (selective gold)	08-65-0816
Rated Contact Current	2.5 A
Rated Wire Size	AWG 22 thru 30

Table 4-6 J4 Mating Connector

4.7.5 J5 Mating Connector

J5 is used internally, thus no mating connector is required.

4.7.6 Control Connector J6

The control connector is a Molex KK header with 0.100" centers. The Molex part numbers for the mating housing and crimp-style snap-in terminals are listed below. There may be equivalent connectors available from other manufacturers.

J6	Molex P/N
Connector Circuits (pins)	10
Mating Housing with ramps & ribs	22-01-3107
Crimp terminal (selective gold)	08-65-0816
Rated Contact Current	2.5 A
Rated Wire Size	AWG 22 thru 30

Table 4-7 J6 Mating Connectors

4.8 Signal Descriptions and Remarks

Signal	Description/Remarks
AC Line	Highest in potential compared to earth ground. Should be connected to the AC power switch.
AC Neutral	Closest in potential to earth ground. Should not be connected to a single-pole power switch.
DC Return	XL275 ground for all outputs and status/control signals. It is recommended that all four pins on J2 be wired in parallel.
V1	The main output (+) capable of 275W. It is recommended that all four output pins be wired in parallel.
V1 Sense (+)	Remote sense for V1 at load (compensates for wiring losses)
V1 Sense (-)	Remote sense for DC Return at load (affects V1, see above)
V1 Trim Input	Connect a resistor between this pin and DC Return to increase the V1 output voltage. Connect a resistor between this pin and V1 to decrease the output voltage. See Section 3.2
V1 Current Share	This analog signal is both an input and output and is used to evenly distribute the total load current amongst two or more XL275 power supplies wired in parallel. The signal also indicates the approximate load current of any single power supply. See Section 3.5.
V2 (+12Vaux)	Provides 1A of 12V power for fans. Uses common ground DC Return. Turns off with V1
V3 (+5 V _{standby})	Provides 1A of 5V power whenever AC power is presents. Uses common ground DC Return
PS_ON	A low-logic level enables the V1 and V2 outputs. Pulled-up by 5K resistor to +4.5V. Factory default is shorted to DC Return with removable jumper. See Section 5.5
Power Good	A high-logic level (4.5V) indicates the output power is in regulation for at least the next 2mS. See Section 5.2
Power Good LED	Connect to the anode of an LED whose cathode is connected to DC Return. Will illuminate the LED when Power Good is high. See Section 5.2
Standby LED	Connect to the anode of an LED whose cathode is connected to DC Return. Will illuminate the LED when PS_ON is open or high. See Section 5.3
FAN2: Tachometer Input	The tachometer output of a single fan may be connected to this input. The loss of the tachometer signal is detected and can be reported over the optional serial data interface.
FAN2: Controlled Output	This output can drive a 12V fan and turns on only when the ambient temperature approaches the normal operating limits. See Section 3.10
I ² C Serial Data	Optional: Provides PMBus [™] control/status interface
I ² C Serial Clock	Optional: Provides PMBus [™] control/status interface

Table 4-8 Signal Descriptions and Remarks

Pin	Signal
J1-1	AC Line
J1-2	No Pin
J1-3	AC Neutral
Pin	Signal
J2-1	V1 (+ Output)
J2-2	V1 (+ Output)
J2-3	V1 (+ Output)
J2-4	V1 (+ Output)
J2-5	V1 Sense (+)
J2-6	DC Return
J2-7	DC Return
J2-8	DC Return
J2-9	DC Return
J2-10	V1 Sense (-)
Pin	Signal
J3-1	V1 Trim Input
J3-2	V3 (+5V Standby)
J3-3	DC Return
J3-4	V1 Current Share
J3-5	DC Return
J3-6	V2 (+12Vaux)
Pin	Signal
J4-1	V2 (+12Vaux (Fan 1))
J4-2	DC Return
Pin	Signal
J6-1	FAN2: Tachometer Input
J6-2	I ² C Serial Data
J6-3	I ² C Serial Clock
J6-4	Power Good (output, high-true)
J6-5	Power Good LED (+output)
J6-6	Standby LED (+output)
J6-7	DC Return
J6-8	PS_ON (input, low-true)
J6-9	DC Return
J6-10	FAN2: Controlled Output (derived from +12Vaux)

Table 4-9 Pin Assignments in Pin Order

Signal	Pin
DC Return	J2-6
DC Return	J2-7
DC Return	J2-8
DC Return	J2-9
DC Return	J3-3
DC Return	J3-5
DC Return	J4-2
DC Return	J6-7
DC Return	J6-9
V1 (+ Output)	J2-1
V1 (+ Output)	J2-2
V1 (+ Output)	J2-3
V1 (+ Output)	J2-4
V1 Sense (-)	J2-10
V1 Sense (+)	J2-5
V1 Trim Input	J3-1
V1 Current Share	J3-4
V2 (+12Vaux)	J3-6
V2 (+12Vaux (Fan 1))	J4-1
V2-Switched +12Vaux (FAN2)	J6-10
FAN2 Tachometer Input	J6-1
V3 (+5V Standby)	J3-2
PS_ON (input, low-true)	J6-8
Power Good (output, high-true)	J6-4
Power Good LED (+output)	J6-5
Standby LED (+output)	J6-6
I ² C Serial Data	J6-2
I ² C Serial Clock	J6-3

Table 4-10 Pin Assignments in Signal Order

All outputs and inputs are referenced to DC Return. See Section 3.2 for details.

5.

Timing and Control

5.1 Power Supply Timing

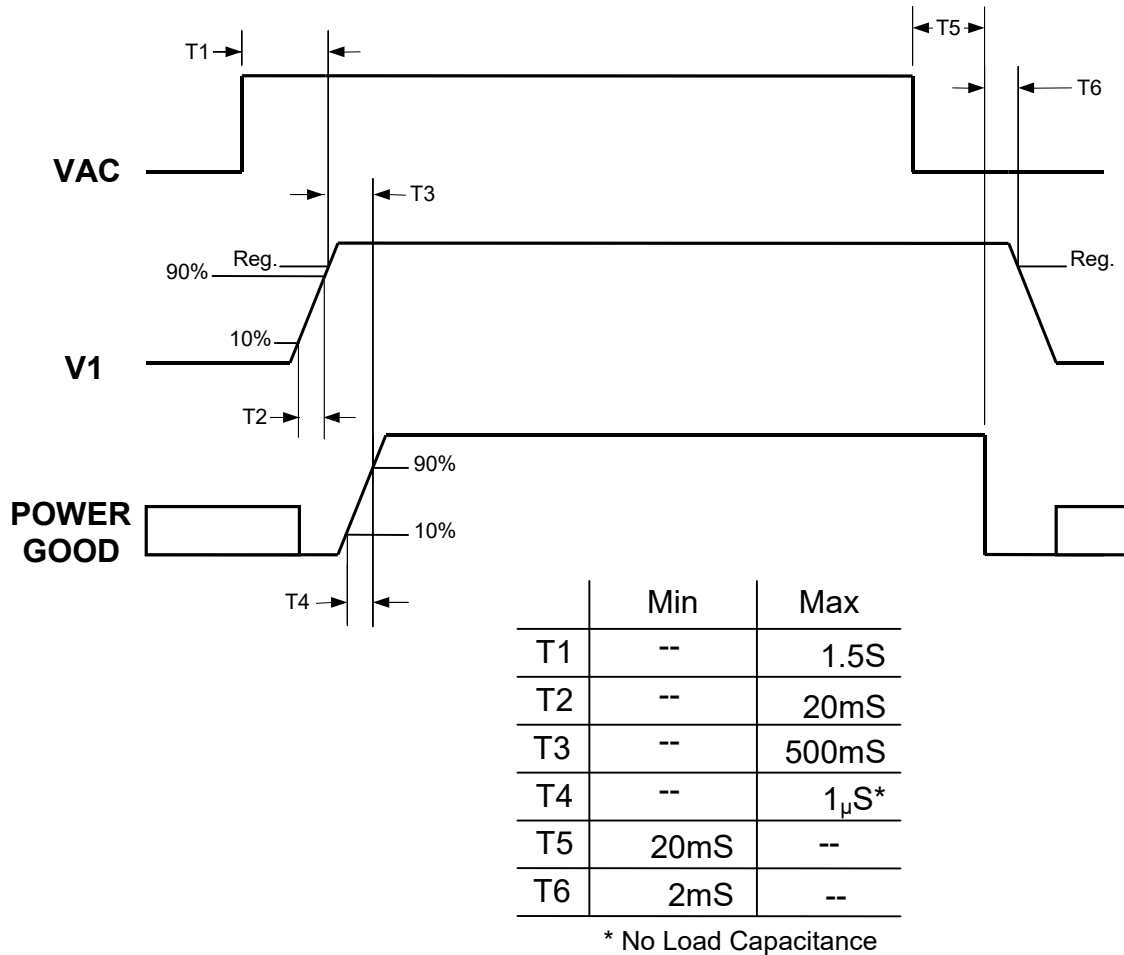

Figure 5-1 XL275 Timing Diagram

5.2 Power Good: Outputs and LED

The Power Good signal provides a high logic level to indicate the DC outputs are within their regulation limits and that sufficient mains energy is stored by the power supply to ensure continuous power operation within specification for the duration of the hold-up time. When the AC power is removed for a period longer than 20ms, the Power Good signal transitions to a low logic level. The Power Good signal emanates from the CMOS microcontroller and is capable of sinking 20mA or sourcing 10mA. The green onboard Power Good LED (located behind J6) illuminates whenever the Power Good output is high.

The Power Good LED output follows the logical Power Good output but is intended to directly drive an external LED through an internal 470-ohm ballast resistor from a 4.4V source. The cathode of the external LED should be connected to DC Return.

5.3 Standby LED Output

The Standby LED output is designed to directly drive an LED from an internal 4.4V source through a 470-ohm ballast resistor. This output will go high when the PS_ON input is open or false, meaning the main output is disabled. The cathode of the external LED should be connected to DC Return.

5.4 AC LED

The amber AC LED illuminates whenever AC power is applied and is located adjacent to headers J3 and J4.

5.5 PS_ON Input

This input must be grounded to enable the V1 (main) and V2 (+12Vaux) outputs. It has no effect on +5Vstandby. It is pulled up to 4.5V through a 10K resistor. The input voltage must be less than 0.4V when the output is to be activated and higher than 3.0V when the output is to be disabled. A jumper from J6-8 to J6-7 or J6-9 will enable the main and +12Vaux outputs (factory default: removable jumper installed J6-8 to J6-9). The PS_ON signal must remain in its changed state for 20mS before the change is accepted.

After a steady high level PS_ON signal is detected, the Power Good signal is de-asserted for a minimum of 2mS and a maximum of 4mS before disabling the outputs and starting a 4.2 second restart inhibit timer.

The PS_ON signal must be set low for a minimum of 20mS before the outputs can be enabled. However, the outputs must remain off for a minimum of 4.2 seconds each time they are turned off. This power-off pause is necessary to limit the internal power dissipation to safe levels under fault conditions. Simply leave the PS_ON signal low and the outputs will be automatically re-enabled when it is safe to do so.

There are output enable and disable commands available in the optional PMBus interface. These commands can override the state of the PS_ON input. Likewise, the PS_ON input can override the last PMBus command. Just remember that the last commanded on/off state (from interface pin or PMBus) will always take precedence.

The special order S91 option changes the logic sense of the PS_ON input from low-true with a pull-up resistor to high-true with a pull-down resistor. The S91 option requires ordering V3.x firmware. Consult sales for details.

5.6 Voltage Hold-Up Time

The power supply will maintain output regulation per Table 3-1 despite a loss of input power at 100VAC/50Hz and 230VAC/50Hz at maximum continuous output load for a minimum of 22-milliseconds.

5.7 Output Rise Time

For single supply applications, all output voltages shall rise monotonically (always positive slope) from 10% to 90% of their nominal output voltage (as specified in Table 3-1) within 0.2ms to 20ms under any loading conditions specified in Table 3-3.

5.8 Overshoot at Turn On/Turn Off

The output voltage overshoot upon the application or removal of the input mains voltage is less than 10% above the nominal voltage. No opposite polarity voltage is present on any output during turn-on or turn-off.

6.

Ordering Information

The following table provides the N2Power part numbers that should appear on your purchase orders and any N2Power correspondence. All XL275 power supplies are RoHS compliant.

XL275-AC Models without active current sharing		
New Model Number	P/N	Legacy Model Number
XL275-12	400029-02-1	XL275-3 S45
XL275-15	400029-05-4	N/A
XL275-16	400029-06-2	N/A
XL275-18	400029-07-0	N/A
XL275-24	400030-02-9	XL275-5 S45
XL275-28	400032-06-6	N/A
XL275-36	400030-02-9	N/A
XL275-48	400031-02-7	XL275-6 S45
XL275-54	400032-04-1	N/A
XL275-56	400032-02-5	XL275-7 S45

XL275-AC Models with active current sharing		
New Model Number	P/N	Legacy Model Number
XL275-12 CS	400029-01-3	XL275-3
XL275-15 CS	400029-03-9	N/A
XL275-16 CS	400029-04-7	N/A
XL275-18 CS	400029-08-8	N/A
XL275-24 CS	400030-01-1	XL275-5
XL275-28 CS	400032-05-8	N/A
XL275-36 CS	400030-01-1	N/A
XL275-48 CS	400031-01-9	XL275-6
XL275-54 CS	400032-03-3	N/A
XL275-56 CS	400032-01-7	XL275-7

Table 6-1 XL275 Model and Part Numbers

For warranty information refer to www.n2power.com

Direct all questions, orders or requests for quotation as follows:

N2Power Order Desk:	orders@n2power.com	805-583-7744 x112
Fax (attention N2Power):		805-583-7749
Sales:	sales@n2power.com	805-583-7744 x122
Technical Support:	techsupport@n2power.com	805-583-7744 x119
Street Address:	3990-B Heritage Oak Court	Simi Valley CA 93063

7.

Customization

The XL275 is very modular in its design and allows for customization when sufficient quantities are ordered. The following options are available. Please contact sales@n2power.com with your requirements.

Item	Description	Benefit	Detriment
1	Eliminate +12Vaux output.	Reduce cost	May have to provide fan power from another source.
2	Change main output voltage	Meet special requirements and reduce system costs	Increase power supply cost
3	Custom Micro-code	Meet unique system requirements	Development time and cost
4	S91 Option	High-True PS_ON Input with pull-down resistor	Not a stocked item and may cost extra

Table 7-1 XL275 Customization Options