



Product Specification

XL275DC Series

**275-Watt DC to DC
Power Supplies**

705601 Rev 04-20-19

Notices

N2Power is a wholly owned subsidiary of Qualstar Corporation.

N2Power and the *N2Power* logo are registered trademarks of Qualstar Corporation.

Copyright 2009-2019 by Qualstar Corporation — All Rights Reserved

For warranty information refer to www.n2power.com

Information contained in this document is copyrighted by Qualstar Corporation and is intended for use by customers and prospective customers to evaluate and integrate our power supplies. Customers and prospective customers may reproduce this document as needed for these purposes. Reproduction in whole or in part for any other purpose or by any other party is prohibited without prior written permission from Qualstar Corporation.

Every effort has been made to keep the information contained in this document current and accurate as of the date of publication or revision. However, no guarantee is given or implied that the document is error-free or that it is accurate with regard to any specification.

N2Power reserves the right to modify the design or specification without notice. This specification may not be construed as a contractual obligation except as specifically agreed to by *N2Power* in writing at the time of order.

For information about this product specification, please write or call *N2Power* at:

N2Power

130 W. Cochran St., Suite C
Simi Valley, CA 93065

FAX: (805) 583-7749

Phone: (805) 583-7744

E-Mail: sales@n2power.com
www.n2power.com

Table of Contents

1.	Introduction	1-1
1.1	Introduction.....	1-1
1.2	Digital Control	1-2
1.3	Agency Compliance.....	1-3
2.	DC Input.....	2-1
2.1	DC Source Requirements.....	2-1
2.2	Noise filtering	2-1
2.3	Inrush Current Limiting.....	2-1
2.4	Low Input Voltage.....	2-1
2.5	Surge Protection.....	2-2
2.6	Safety Warning	2-2
3.	DCOutputs	3-1
3.1	Output Voltage Regulation	3-1
3.2	Grounding.....	3-1
3.3	No Load Operation.....	3-1
3.4	Voltage Trim	3-2
3.5	Output Current/Power	3-2
3.6	Efficiency	3-3
3.7	Unloaded Power Consumption.....	3-6
3.8	Cooling.....	3-6
3.9	Output Ripple/Noise	3-7
3.10	FAN Outputs.....	3-8
3.11	Local and Remote Sensing	3-8
3.12	Parallel Operation	3-8
3.13	Power Supply Protection	3-11
3.14	Fault Code Summary	3-13
3.15	Output Transients.....	3-14
3.16	Capacitive Loading	3-14
4.	General Specifications.....	4-1
4.1	Environmental	4-1
4.2	Mean Time between Failures.....	4-1
4.3	Component Stress.....	4-1
4.4	Labeling/Marking	4-2
4.5	Weight.....	4-2
4.6	Physical Dimensions.....	4-3
4.7	Mating Connectors.....	4-3
4.8	Signal Descriptions and Remarks.....	4-7

5.	Timing and Control.....	5-1
5.1	Power Supply Timing.....	5-1
5.2	Power Good: Outputs and LED.....	5-1
5.3	Standby LED Output.....	5-2
5.4	VIN LED.....	5-2
5.5	PS_ON Input.....	5-2
5.6	Voltage Hold-Up Time.....	5-3
5.7	Output Rise Time.....	5-3
5.8	Overshoot at Turn-On/Turn-Off.....	5-3
6.	Ordering Information.....	6-1
7.	Customization.....	7-1

1.1 Introduction

This specification defines the design and performance characteristics of a 48VDC input, single output, 275-watt, open frame switching mode power supply. The XL275-DC models are listed in Table 3-1. They provide 12V, 24V, 48V, 54V or 56V DC primary outputs. Except for the input connector J1, the XL275-DC input series is pin-compatible with the XL275-AC input series.

Additionally, all models provide a +5 V_{standby} output (1.0A max.) whenever DC input power is applied. A +12 V_{aux} output (1.0A max.) is also available on all models whenever the main output is on. This output is repeated on the FAN connector to provide 10CFM of cooling airflow for the XL275-DC. The main and +12 V_{aux} outputs may be disabled by opening the PS_ON/ input.

Models with optional active current sharing (CS suffix on model number) can also be used in redundant or N+1 configurations, with up to 4 units connected in parallel.



Figure 1-1 The XL275-DC Series has a natural-aluminum finished chassis

1.2 Digital Control

The XL275-DC uses a dedicated digital microcontroller to supervise its operation. Doing so greatly improves timing accuracy and eliminates stored charge delays found in analog control circuits. The microcontroller samples the following parameters 500 times per second and uses intelligent algorithms to act upon the constantly changing conditions.

- DC input voltage
- Main Output Voltage
- Main Output Current
- Auxiliary 12V output voltage
- Output Transformer temperature
- Ambient temperature
- Fan tachometer

The microcontroller is responsible for enabling the main output whenever all of the required startup conditions are met and shutting it down upon command, loss of input power or whenever the power supply's longevity is threatened by excessive loads or temperatures. It will provide the host system with advanced warning of an impending shutdown whenever one of these conditions occurs.

To minimize acoustic noise; the microcontroller will turn on the 12V fan connected to J6 whenever the ambient temperature exceeds 45°C, and turn it off whenever the ambient temperature drops below 40°C. A fan connected to J4 will run continuously regardless of the ambient temperature.

An optional PMBus digital communications interface is also available to allow up to four XL275-DC units to communicate over the same PMBus. This communications interface allows routine remote control of the main outputs and the 12V fans. It can also notify the host if a fan fails (lost tachometer pulses). The host can also query the microcontroller for its output voltage and current as well as the ambient and transformer temperatures. The PMBus option also allows for variable speed fan control based on XL275-DC's ambient temperature. A PMBus User's Guide is available upon request.

Because it's programmable, the microcontroller firmware can be customized to fit an OEM customer's requirements.

1.3 Agency Compliance

The XL275-DC complies with the following international agency standards:

Safety	Complies with Standard	Remarks
United States	UL 60950-1 Second Edition UL 62368-1 Second Edition (Information Technology Equipment)	Leakage Current – see table 2-2 Hi-pot – 500vdc for 1 second. (SEC to P.E.) 2121vdc for 1 second (Primary to SEC and P.E.)
Canada	CSA 22.2: 60950-1	
EU Council	2006/95/EC	Low Voltage Directive
International	IEC 60950-1 (2005) Second Edition IEC 62368-1 (2014) Second Edition	

EMC	Complies with Standard	Remarks
United States	FCC part 15, subpart B	Conducted emissions Limits per CISPR 22 Class B Tested to ANSI C63.4: 2003
EU Council	2004/108/EC	EMC Directive
International	EN 61204 -3 (refers to the following) EN 55022 Class B EN 55024 (refers to the following) EN 61000-4-3 EN 61000-4-4 EN 61000-4-5 EN 61000-4-6 EN 61000-4-11	Low Voltage Power Supplies – DC Output Conducted emissions Limits per CISPR 22 Class B Immunity Radiated Susceptibility Fast Transient/Burst Immunity Power Mains Surge Immunity RF Immunity Voltage Dips, Short Interruptions

Reduction of Hazardous Substances (RoHS)	Complies with Standard	Remarks
EU Council	2002/95/EC	RoHS Directive





Marks of Conformance	
United States & Canada	 (Underwriters Laboratories File E211115)
Europe	
EU Council	
RoHS	 

Table 1-1 Agency Compliance

2.1 DC Source Requirements

The XL275-DC power supply operates on DC input power from 37VDC to 76VDC. It is reverse polarity protected and will not function or be damaged from reversed inputs of less than 76VDC. Both the plus and minus input lines are fused at 10A.

Parameter	Minimum	Maximum
DC Input Voltage	37VDC	76VDC
DC Input Current @ 37VDC	–	9.0A
DC Input Current @ 48VDC	–	6.8A
DC Input Current @ 76VDC	–	4.3A

Table 2-1 XL275-DC Input Parameters

2.2 Noise filtering

A five-pole L-C input filter reduces the switching noise levels on the input terminals generated by the XL275-DC to below FCC and CISPR 22 Class B requirements. It also reduces high-frequency noise on the input from getting to the XL275DC's output. The input filter utilizes capacitors across the input lines and from both input lines to the chassis. The capacitance from either input line to chassis is approximately 10,000 picofarads.

2.3 Inrush Current Limiting

A current inrush occurs when the input filter capacitors are initially charged. After this inrush, the soft-start circuitry gradually ramps up the input current until the output load is applied.

Repetitive ON/OFF cycling of the DC input voltage should not damage the power supply or cause the input fuses to fail.

2.4 Low Input Voltage

The application of DC input voltages below 37VDC shall not damage the XL275-DC.

2.5 Surge Protection

The DC inputs are shunted by a 100VDC 40-joule varistor surge suppressor to protect the XL275-DC against unexpected high-voltage transients.

2.6 Safety Warning

WARNING

The XL275-DC is a component, not a stand-alone power supply. It must be mounted inside a protective enclosure to prevent accidental shock by contact with the supply. Hazardous voltages are present while DC input power is applied to the XL275-DC. Allow 1-minute for storage capacitors to discharge after removing input power before handling the XL275-DC.

The safety ground connection is the chassis itself and it must be connected to Protective Earth.

3.

DC Outputs

3.1 Output Voltage Regulation

The DC output voltages shall remain within the minimum and maximum limits of Table 3-1 when measured at the power supply connector under all specified input and environmental conditions contained herein. The regulation accuracy is measured with load currents between the minimum and maximum load currents listed in Table 3-3.

Model	Output	Rated Voltage	Regulation	Minimum (VDC)	Nominal (VDC)	Maximum (VDC)	Remote Sense
XL275-12DC	V1	+12V	±3%	11.640	12.000	12.360	V1/RTN
	V2	+12V _{aux}	±5%	11.0	11.6	12.2	None
	V3	+5V _{standby}	±5%	4.750	5.000	5.250	None
XL275-24DC	V1	+24V	±3%	23.280	24.000	24.720	V1/RTN
	V2	+12V _{aux}	±5%	11.0	11.6	12.2	None
	V3	+5V _{standby}	±5%	4.750	5.000	5.250	None
XL275-48DC	V1	+48V	±3%	46.560	48.000	49.440	V1/RTN
	V2	+12V _{aux}	±5%	11.0	11.6	12.2	None
	V3	+5V _{standby}	±5%	4.750	5.000	5.250	None
XL275-54DC	V1	+54V	±3%	52.380	54.000	55.620	V1/RTN
	V2	+12V _{aux}	±5%	11.0	11.6	12.2	None
	V3	+5V _{standby}	±5%	4.750	5.000	5.250	None
XL275-56DC	V1	+56V	±3%	54.320	56.000	57.680	V1/RTN
	V2	+12V _{aux}	±5%	11.0	11.6	12.2	None
	V3	+5V _{standby}	±5%	4.750	5.000	5.250	None

Table 3-1 XL275-DC Output Voltage Specifications

3.2 Grounding

All DC outputs, status outputs and control inputs share a common DC Return found on all output connectors. DC Return floats from the chassis (Protective Earth) with a 4700pF, 250VAC capacitor between them.

3.3 No Load Operation

A no load condition will not damage the supply or cause a hazardous condition. The power supply will remain stable and operate normally after application of a load. The Power Good logic output will indicate normal operation when the supply is unloaded.

3.4 Voltage Trim

A voltage trim input pin is provided to allow the user to adjust the V1 output up or down by up to 5%. Connecting a resistor between this pin and DC Return will increase the output voltage while connecting a resistor between this pin and the V1 output will decrease the output voltage. The ability of the V1 output to maintain its specified regulation accuracy under severe load or line conditions could be diminished by trimming the output to a higher than nominal voltage. The trim range is limited to +/- 5% as determined by the Up/Down 5% resistor values listed in Table 3-2. Only resistance values greater than or equal to those listed should be used.

Model	V1 Up 3%	V1 Up 5%	V1 Down 3%	V1 Down 5%
XL275-12DC	17.8K	4.32K	124K	68.1K
XL275-24DC	17.8K	4.32K	294K	169K
XL275-48DC	17.8K	4.32K	649K	383K
XL275-54DC	17.8K	4.32K	732K	432K
XL275-56DC	17.8K	4.32K	768K	453K
Connect Trim Resistor to:	DC Return	DC Return	V1 Output	V1 Output

Table 3-2 Minimum Trim Resistors for Maximum Trim

When two or more XL275-DC's are operating in parallel, each unit should be trimmed with the same resistor value connected to the same terminals.

3.5 Output Current/Power

The maximum available output power is always a function of the cooling airflow and its temperature. The maximum of 275-watts combined total power from all outputs is only available with a minimum of 10-CFM of forced air-cooling at no more than 50°C.

Model	Output	Rated Voltage	Maximum Load	Current Share Voltage
XL275-12DC	V1	12 V	22.9 A	2.02 V @ Max. load
XL275-24DC	V1	24 V	11.5 A	2.02 V @ Max. load
XL275-48DC	V1	48 V	5.7 A	2.02 V @ Max. load
XL275-54DC	V1	54 V	5.1 A	2.02 V @ Max. load
XL275-56DC	V1	56 V	4.9 A	2.02 V @ Max. load
All	+5 V _{standby}	5 V	1.0 A	N/A
All	+12 V _{aux}	12 V	1.0 A	N/A

Table 3-3 Maximum Individual Load Currents (sum limited to 275W)

The V1 output current can be easily measured on the V1 Current Share pin (Section 4.8). This positive DC output indicates the approximate output current of a single supply, or of each supply when current sharing parallel units. Do not load this output with any capacitance and use a DC voltmeter for measurement. See Table 3-3 above for output scaling. Too much capacitance is present if the V1 output voltage increases when making the above measurement.

3.6 Efficiency

The power supply efficiency varies with the output load and the input voltage. The following graphs show the efficiency of the main output with 10-CFM of cooling air at 25°C after a 15-minute warm-up period. The +5 V_{standby} and +12 V_{aux} outputs were unloaded.

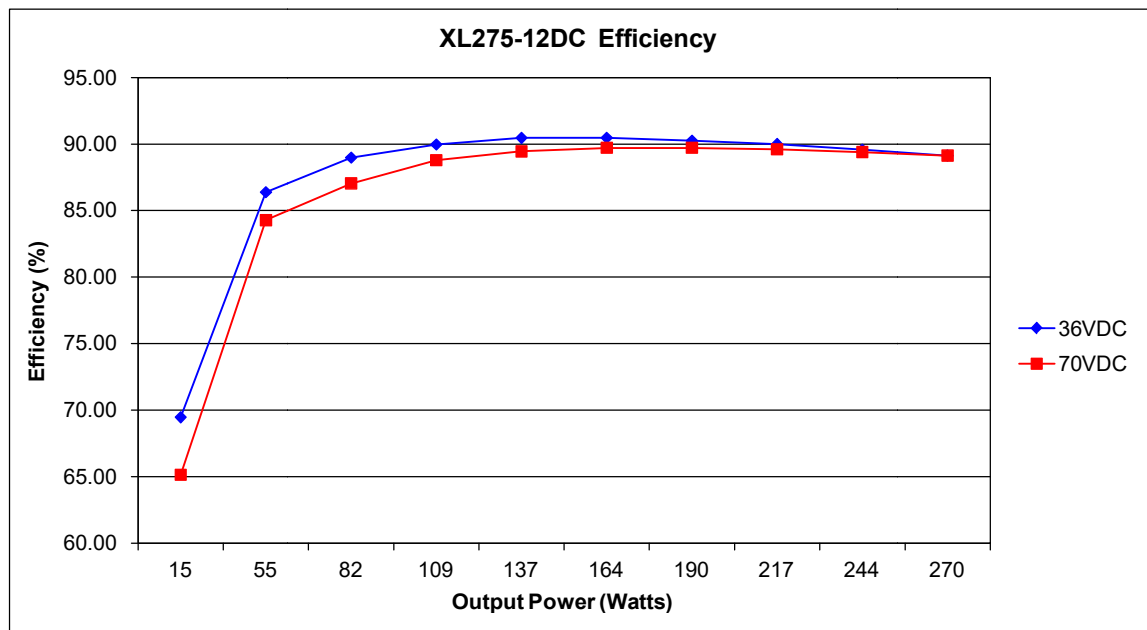

Figure 3-1 XL275-12DC Efficiency

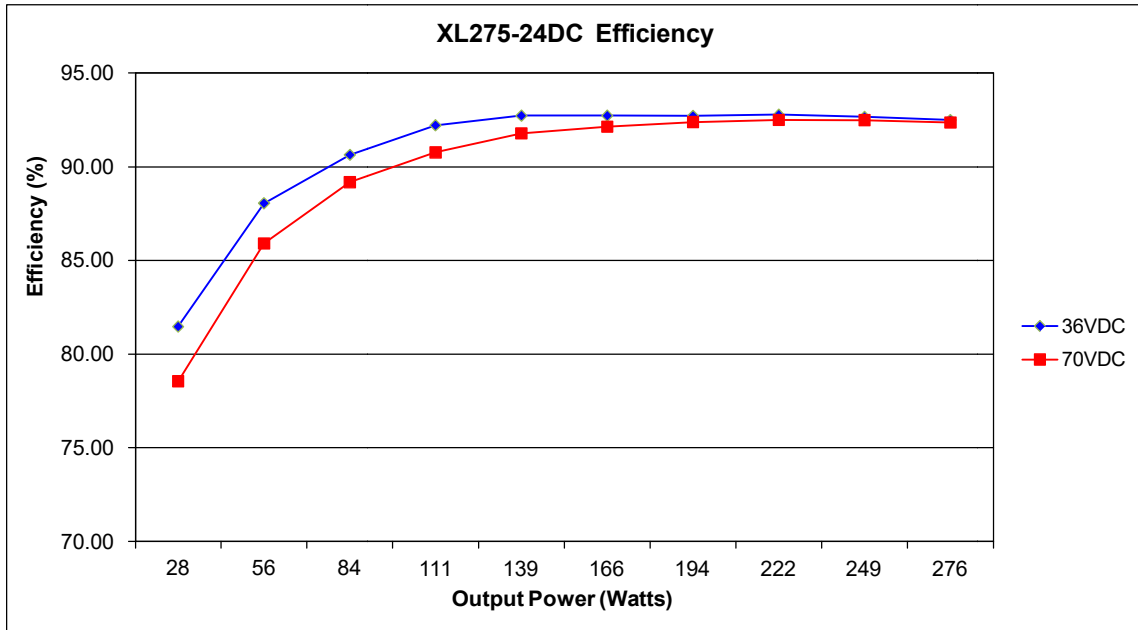

Figure 3-2 XL275-24DC Efficiency

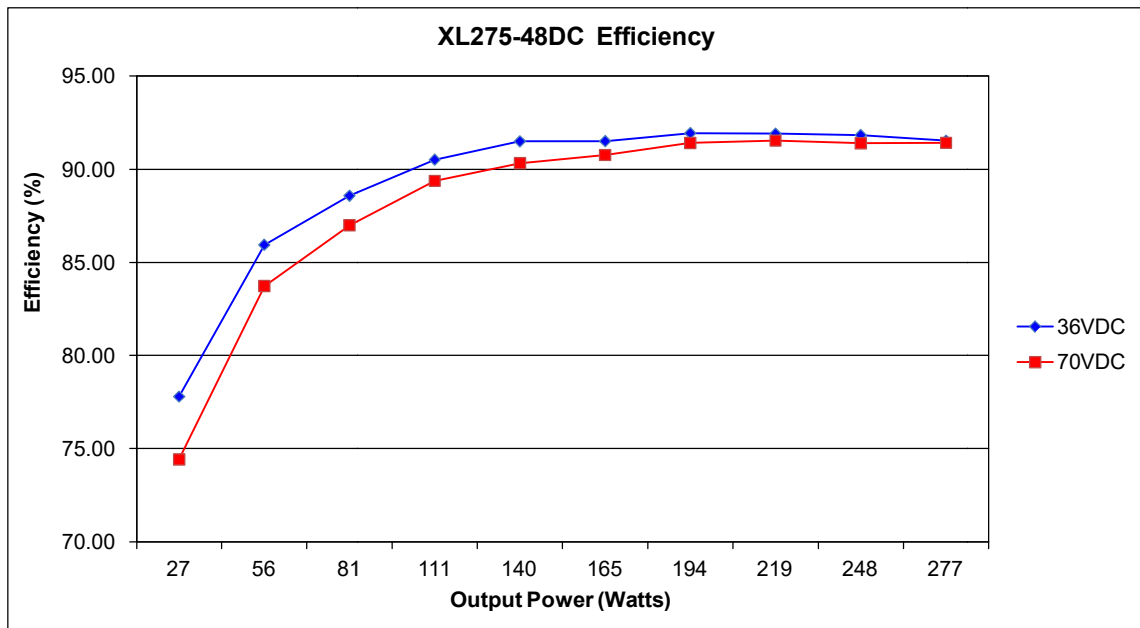

Figure 3-3 XL275-48DC Efficiency

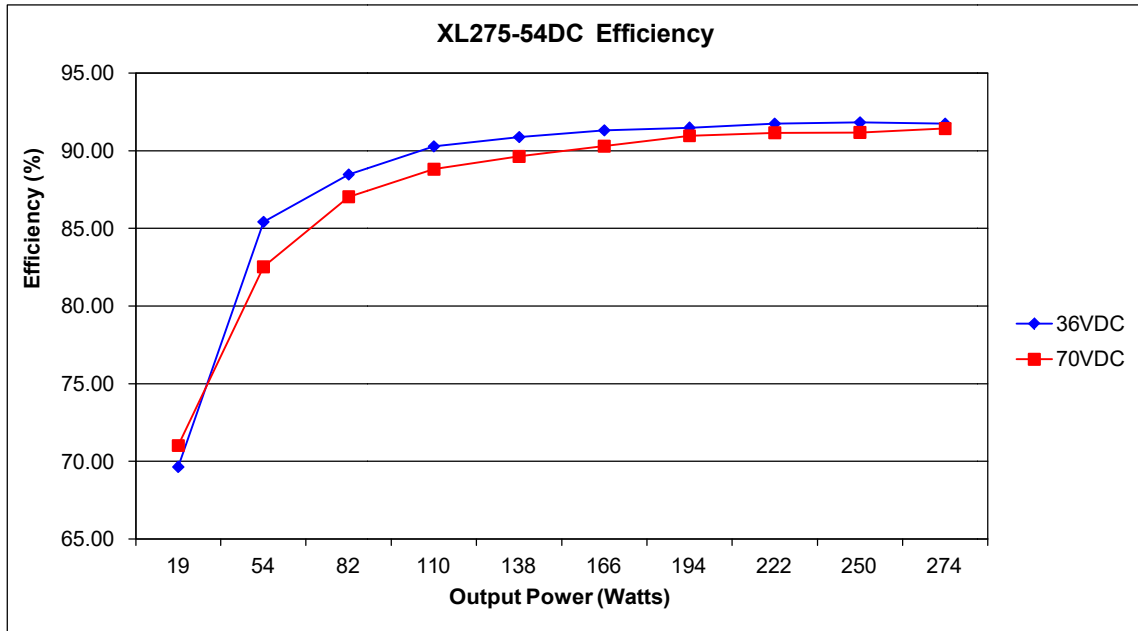

Figure 3-4 XL275-54DC Efficiency

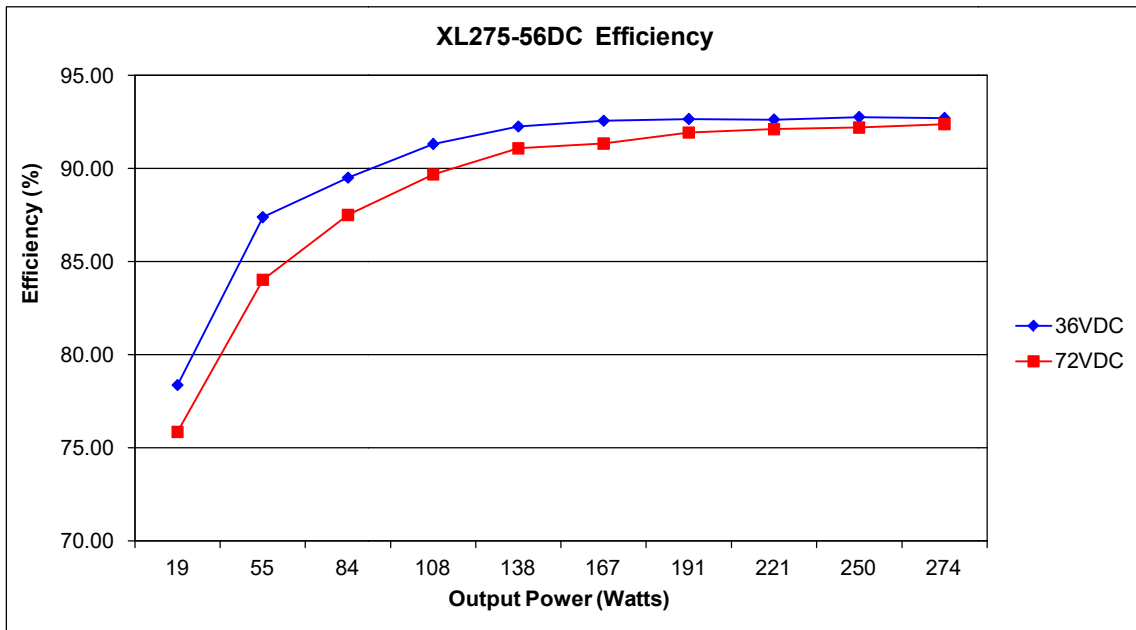

Figure 3-5 XL275-56DC Efficiency

3.7 Unloaded Power Consumption

When completely unloaded and at any normal input voltage, the XL275-DC consumes about 3-watts with a high PS_ON input (disabled) and about 8-watts with a low PS_ON input (enabled).

3.8 Cooling

The XL275-DC power supplies can operate with convection cooling at temperatures below 50°C when total power output is less than 150-watts and they are mounted open side up. 10-CFM of forced-air cooling at a maximum of 50°C is required when the output power exceeds 150-watts. The cooling airflow must be either co-planar with the circuit board or it must impinge downward in the center of the open topside. The XL275-DC may be mounted in any attitude when forced-air cooled.

3.8.1 Output Power Derating at Elevated Temperatures

The XL275-DC can be operated with cooling air temperatures above 50°C by linearly derating the total maximum output power (or current) by 2.5%/°C from 50°C to 70°C (see Figure 3-6).

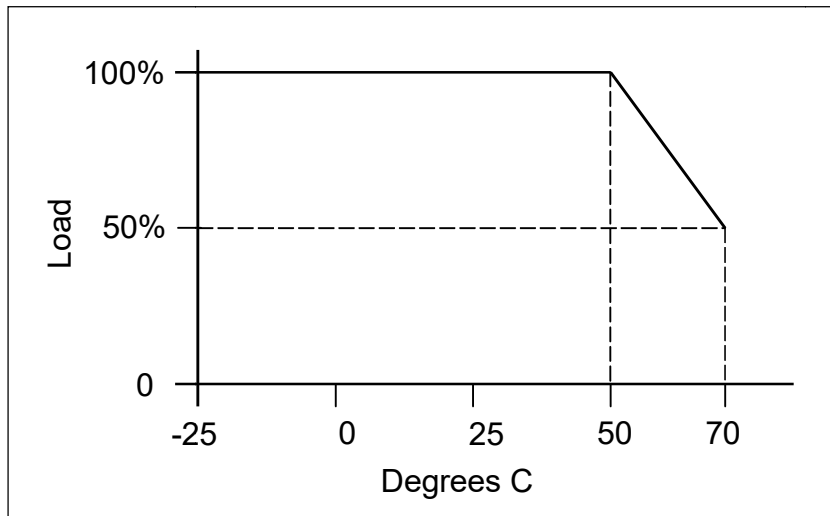

Figure 3-6 XL275-DC Output Power vs. Ambient Temperature Envelope

3.8.2 Over-temperature Shutdown

The power supply is equipped with internal temperature sensors. Failure to provide adequate cooling airflow below the maximum operating temperature will result in the power supply shutting down the V1 and +12V_{aux} outputs while the +5V_{standby} will remain operational. The V1 and +12V_{aux} outputs will be automatically restored when the temperature of the built-in temperature sensor cools adequately.

3.9 Output Ripple/Noise

Output ripple voltage and noise are defined as periodic or random signals over a frequency band of 10 Hz to 20 MHz. Measurements are to be made with an oscilloscope with a 20 MHz bandwidth. Outputs should be bypassed at the connector with a 0.1 μ F ceramic disk capacitor and a 10 μ F tantalum capacitor to simulate system loading (see Figure 3-7).

The ripple voltage of the output is measured at the pins of the mating connector. Ripple and noise shall not exceed the limits specified in Table 3-4 under any condition of line voltage and frequency specified in Section 2.1 and DC loading specified in Section 3.5.

Model	Output	Rated Voltage	Maximum Ripple+Noise (peak-to-peak)
XL275-12DC	V1 (main)	+12 V	100 mV
XL275-24DC	V1 (main)	+24 V	200 mV
XL275-48DC	V1 (main)	+48 V	200 mV
XL275-54DC	V1 (main)	+54 V	200 mV
XL275-56DC	V1 (main)	+56 V	200 mV
All	V2 (+12 V _{aux})	+12 V	80 mV
All	V3 (+5 V _{standby})	+5 V	50 mV

Table 3-4 Ripple + Noise Output Voltage

3.9.1 Ripple/Noise Test Setup

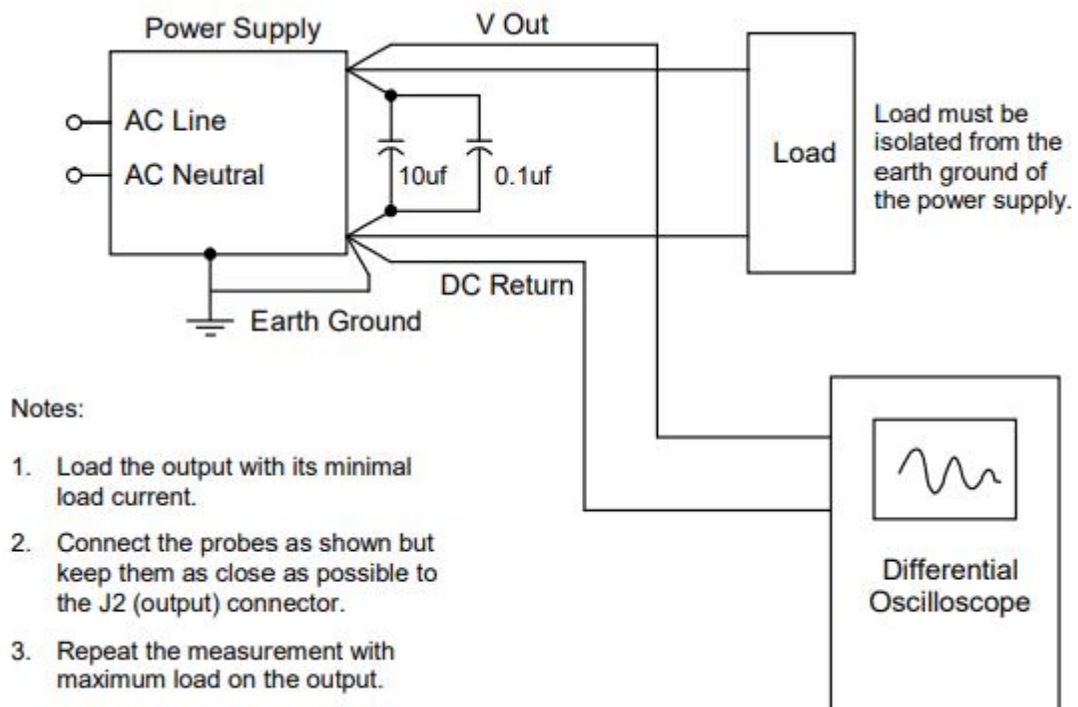

Figure 3-7 Ripple Noise Measurement Setup

3.10 FAN Outputs

There are two outputs for 12VDC fans. J4 is a 2-pin header dedicated to driving a fan. This 11.6V output remains on as long as V1 is enabled and the V2 load current is less than 1.0A. This output may be wired in parallel with the same output on other XL275-DCs to provide a redundant 1.0A source of fan power.

The second fan output appears on J6-10. This 11.6V output is limited to 1.0A less any current being drawing from J4 and is not energized until the ambient temperature exceeds 45°C or the output transformer (T2) temperature exceeds 100°C. This output must not be connected to any other outputs from this or any other power supply.

Both fan outputs may be simultaneously loaded as long as the sum of their currents does not exceed 1.0A.

3.11 Local and Remote Sensing

Remote sensing is provided to compensate for voltage drops in the V1+Output and the DC RETURN wiring to the V1 load. The voltage at the remote sense inputs must never be allowed to differ by more than 0.5-volts from their respective output and return pins. If the Remote Sense inputs are left open, the output voltage at the J2 terminals will still meet the load regulation specification.

Remote sense lines can be extended through bulkhead connectors and right to the critical load within a user's system. Unplugging the remote sense lines simply causes a drop in the voltage at the load. Connecting the remote sense lines lifts the voltage at the load to within the regulation specification but may increase the V1 voltage at J2 above the regulation limits. See Figure 3-8. Power output is always determined by the output voltage at J2, not at the load.

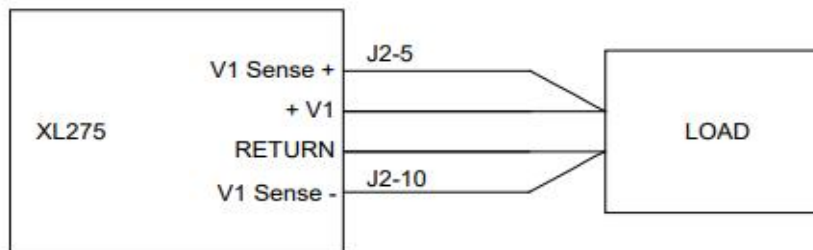

Figure 3-8 Remote Sense Wiring

3.12 Parallel Operation

The V1 output of two, three or four XL275-DC CS versions may be connected in parallel to provide higher V1 output power. They can also be used in an N+1 configuration to provide higher output power and greater reliability. Each model has a built-in output OR-ing diode (actively switched MOSFET) and a Current Share signal for parallel operation. Remote sensing may still be used in parallel operation.

XL275-DCs running in parallel are capable of starting with a total load that exceeds the capability of an individual unit, however, the rising output waveform may not be monotonic. They are also fully compatible with hot swapping and will tolerate the dramatic load fluctuations encountered in a N+1 redundant configuration when supplies are removed and replaced. Because of the inherent limitations of current sharing, it is recommended that the total load not exceed 92%-94% of the sum of the rated outputs (see Table 3-5). Assuming all XL275-DC output power is dedicated to the main output (no +12 V_{aux} +5 V_{standby} use), the following table lists possible total system output power.

Number of XL275-DCs	N Configuration	N+1 Configuration
1	275 watts	N/A
2	520 watts	275 watts
3	770 watts	520 watts
4	1015 watts	770 watts

Table 3-5 Total Output Power in N and N+1 Configurations

3.12.1 Current Sharing Connections

The Current Share signal (see Table 4-9) of each supply operating in parallel must be connected together. The output voltage of multiple power supplies in parallel is generally slightly higher than that of the supply with the highest stand-alone output voltage.

Current sharing does not require the Remote Sense signals be connected together, but the sharing accuracy may not meet published specification unless they are also connected together. See Figure 3-9 for an example of wiring two XL275-DC's in parallel. Three and four supplies would be wired in a like manner with all four V1 Current Share signals tied together.

With active current sharing systems, the Current Share signal is a high-impedance analog output/input on each supply. This signal is quite susceptible to noise pickup and care must be used in wiring the Current Share signals of multiple supplies together. Any external capacitance on this signal will cause the output voltages of all supplies to rise and will compromise sharing accuracy. Do not connect any capacitance to this signal.

The current sharing signal is referenced to the same DC Return as the V1 output. It is imperative that the ground wiring from the load to each shared supply be of equal length and have the lowest possible resistance. This means four individual 18 AWG wires should be run from J2 (pins 6-9) of each supply to a star ground terminal or ground plane at the load.

Measure the DC voltage between J3 pin 5 of each supply while operating under full load. This is the DC Return signal and worst case difference should be less than 10mVDC. Measure the current share DC voltage from J3-4 to J3-5 of any supply. The value of the worst case difference in DC Return voltages divided by the normal current share voltage should be considered an error value. If the current share voltage is 1V and the DC Returns differ by as

much as 100mV, this creates an additional 10% error ($0.1/1 = 10\%$) that detracts from the current sharing accuracy.

Power Good signals must not be wire ORed together. Each individual Power Good signal should be monitored separately by the user's system.

3.12.2 Current Share Accuracy

When all the current share signals are connected together and all the Remote Sense signals are connected together, the load delivered by any two of the sharing supplies will not vary by more than 5% at full load. The sharing accuracy decreases with lower loads and with poor grounding techniques (see Section 3.12.1).

3.12.3 +5 V_{standby} Parallel Operation

The +5 V_{standby} output has a series Schottky rectifier just before the output connector that allows this output to be connected in parallel with the same output on like supplies. By doing so, the +5 V_{standby} output will remain alive as long as one of the paralleled supplies is functioning. The output current rating does not increase beyond the single supply rating.

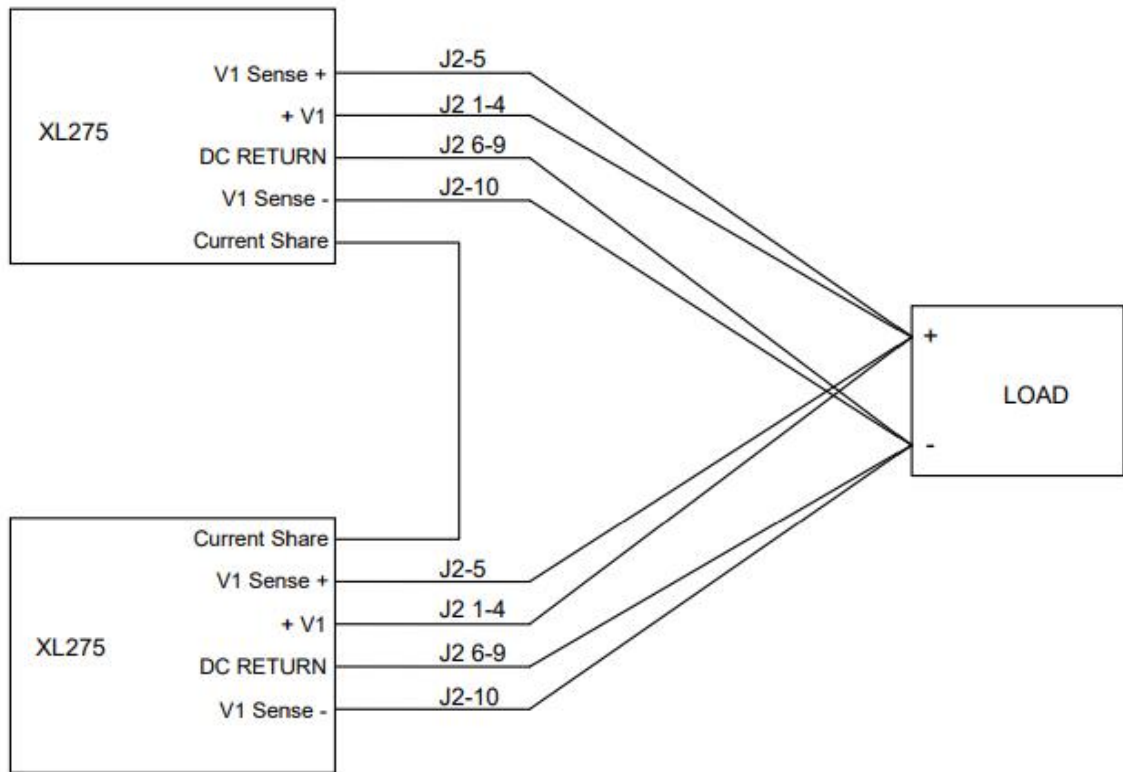

Figure 3-9 Current Sharing Wiring Example

3.12.4 +12 V_{aux} Parallel Operation

The +12 V_{aux} output has a series Schottky rectifier just before the output connector that allows this output to be connected in parallel with the same output on like supplies. By doing so, the +12 V_{aux} output will remain alive as long as one of the paralleled supplies is functioning. The output current rating does not increase beyond the single supply rating and the net output voltage is closer to 11.6V than 12V.

3.12.5 Transients

The output rise time and monotonic requirements of Section 5.7 may not be met when the load exceeds 275-watts, because of the difference in start-up times of the paralleled power supplies.

When the DC input to one of the parallel power supplies is disconnected or reconnected, or a power supply fails, the transient on the V1 output is within 6% of nominal output voltage. The output voltage may ramp to a new nominal voltage within the regulation band after a configuration change.

3.13 Power Supply Protection

There are several different protection circuits designed to protect the load and the XL275-DC from component failures and extraordinary circumstances.

3.13.1 Over Temperature Protection

If the XL275-DC is operated without adequate cooling, it will sense an over-temperature condition and shut down the V1 (main) and V2 (+12V_{aux}) outputs. There are two possible over-temperature conditions: an ambient temperature in excess of approximately 90°C or the main transformer temperature in excess of approximately 120°C. Excessive transformer temperature can be caused by inadequate cooling or excessive combined output power of V1 and V2. Following an over-temperature alarm, the XL275-DC will automatically restart after it has cooled down to below its maximum operating temperature.

3.13.2 Over-Voltage Protection

Over-voltage protection is only provided on the V1 output. No single internal fault is able to cause a sustained over voltage condition on the V1 output. When an over-voltage condition occurs, the power supply will shut down and will not restart until AC power is turned off and back on (off for 5-seconds minimum) or the PS_ON/ signal is recycled (off for 25mS or longer).

The XL275-DC will shut down under the following over voltage conditions:

Model	Main Output	Over-Voltage Protection Threshold		
		Minimum	Nominal	Maximum
XL275-12DC	12 V	13.9 V	14.4 V	14.9 V
XL275-24DC	24 V	27.8 V	28.7 V	29.7 V
XL275-48DC	48 V	56.0 V	57.7 V	59.5 V
XL275-54DC	54 V	63.0 V	64.9 V	66.9 V
XL275-56DC	56 V	64.2 V	66.3 V	68.3 V

Table 3-6 Over-Voltage Protection Limits

3.13.3 Under-Voltage Protection

The Power Good signal goes false whenever the V1 output voltage falls below 90% of nominal value for 4mS or more. The Power Good signal will be automatically restored if the output rises above 93% of the nominal for 4mS.

An under-voltage fault occurs whenever the V1 output voltage falls below 80% of nominal for more than 30mS. In this case, the V1 and V2 outputs are immediately disabled and the Power Good status is set false. This off condition will remain until AC power is turned off and back on (off for 5-seconds minimum) or the PS_ON/ signal is recycled (off for 25mS or longer).

Model	V1	Under-Voltage Protection		
		PG falls	PG Recovers	Shutdown
XL275-12DC	12 V	10.8 V	11.2 V	9.6 V
XL275-24DC	24 V	21.6 V	22.3 V	19.2 V
XL275-48DC	48 V	43.2 V	44.6 V	38.4 V
XL275-54DC	54 V	48.6 V	50.2 V	43.2 V
XL275-56DC	56 V	50.4 V	52.1 V	44.8 V

Table 3-7 Nominal Under-Voltage Protection Thresholds

3.13.4 Short-Circuit and Over-Current Protection

V1 load currents in excess of 115% \pm 5% of the rated output lasting more than 10-milliseconds will cause only the V1 and V2 outputs to shut down. This feature is tested with an ever-increasing load at a rate of 10 A/second starting at the maximum rated load current.

The total RMS output power of all three outputs must still be limited to 275-watts as in this example.

After shutting down from overload, the XL275-DC automatically attempts to restart itself every four-seconds. It will succeed if the V1 load is reduced below the XL275-DC's maximum rated load current within 5-minutes of the initial fault. The AC power must be recycled to

recover from an overload lasting longer than 5-minutes.

An overload on the +12V_{aux} output will not cause V2 to shut down and +12V_{aux} will resume normal operation after the short circuit is removed. For the XL275-12DC model, +12V_{aux} needs to be unloaded before returning to normal operation. An overload on the +5 V_{standby} output will completely disable the power supply, but it will recover after the overload is removed.

3.13.5 Over-Power Protection

In addition to the over-current and short-circuit protection listed above, the XL275-DC will limit its instantaneous output power (pulses less than 10mS in duration) to approximately 520-watts (exclusive of the energy stored in the output capacitors and the 5V Standby power). Exceeding this limit will not damage the power supply and may result in an under-voltage fault code (see below). AC power must be recycled to recover from an under-voltage fault.

Model	V1	Capacitance	Stored Energy
XL275-12DC	12 V	2,400 μ F	0.17 Joules
XL275-24DC	24 V	990 μ F	0.28 Joules
XL275-48DC	48 V	450 μ F	0.52 Joules
XL275-54DC	54 V	450 μ F	0.66 Joules
XL275-56DC	56 V	450 μ F	0.71 Joules

Table 3-8 V1 Nominal Internal Output Capacitance & Stored Energy

3.14 Fault Code Summary

The XL275-DC utilizes a microcontroller to supervise its operation. It is powered by V3 (5V_{standby}) and is not affected by V1 and V2 output faults. It will enable and disable the V1 and V2 output voltages in response to requests on the PS_ON/ input and also provides the Power Good, Power Good LED and Standby LED outputs.

The microcontroller also measures the V1 output voltage and output current in addition to the ambient and main output transformer temperatures. It will shut the V1 (main) and V2 (12V_{aux}) outputs off whenever an abnormal condition occurs that could potentially damage the load or the power supply.

When the microcontroller disables the V1 and V2 output voltages, it blinks an alarm code on the green Power Good LED (located behind J6) and on an optional external Standby LED. A Long blink illuminates the Standby LED while it darkens the Power Good LED for 1000mS while a short blink lasts only 300mS. There is a 100mS pause between blinks and a 2000mS pause before repeating a fault code.

Fault Condition	Ends when...	Blink* Code
Output under-voltage or primary over-temp	Input power is recycled or PS_ON/ is recycled	5-Short
Output over-voltage	Input power is recycled or PS_ON/ is recycled	4-Short
Short-circuit	Attempts to restart every four seconds for up to 5-minutes	3-Short
Over-current	Attempts to restart every four seconds for up to 5-minutes	2-Short
Transformer over-temperature	XL275-DC cools down	Long-Short
Ambient over-temperature	XL275-DC cools down	Short-Long

*Power Good LED located behind J6 blinks off (dark)

*Optional external Standby LED blinks on (light)

Table 3-9 Fault Code Summary

Utilizing an external Standby LED allows a user to see any fault codes on the front panel of the equipment.

3.15 Output Transients

The maximum output voltage transient caused by step load changes will not exceed the output voltage regulation limits by more than 5%. With an DC input as specified in Section 2.1, the power supply will remain stable when subjected to the load transients described below with capacitive loading per Table 3-10:

- Load changes between 75% and 100% on any output
- Load changing repetition of 50 to 333 cycles per second
- Transient load slew rate = 1.0 A/microsecond

3.16 Capacitive Loading

The XL275-DC will startup and operate normally with external load capacitance on the V1 output that does not exceed those listed in Table 3-10.

Output	XL275-12DC	XL275-24DC	XL275-48DC	XL275-54DC	XL275-56DC
V1 (12 V)	4,000 μ F				
V1 (24 V)		2,000 μ F			
V1 (48 V)			500 μ F		
V1 (56 V)				350 μ F	350 μ F
V2 (+12 V _{aux})	350 μ F	350 μ F	350 μ F	350 μ F	350 μ F
V3 (+5 V _{standby})	200 μ F	200 μ F	200 μ F	200 μ F	200 μ F

Table 3-10 XL275-DC Capacitive Loading

4.

General Specifications

4.1 Environmental

The XL275-DC meets or exceeds the following environmental specifications:

Parameter	Conditions	Specification	Remarks
Temperature	Operating	-25°C to 50°C	See cooling requirements
	Non-Operating	-40°C to 85°C	
Relative Humidity	Operating	95% Maximum	Non-Condensing
	Non-Operating	95% Maximum	Non-Condensing
Altitude	Operating	6,561 feet MSL Max.	2,000 meters
	Non-Operating	50,000 feet MSL Max.	15,240 meters
Vibration	No damage	2.4G RMS Maximum	5-500Hz, 10-min. each axis per MIL-PRF-28800F: 3.8.4.1 (Class 3,4)
Mechanical Shock	No damage	30G half-sine, 11mS	Six shocks each axis per MIL-PRF-28800F: 4.5.5.4.1

Table 4-1 Environmental Specifications

4.2 Mean Time between Failures

The calculated MTBF of the power supply is equal to or greater than 200,000 hours of continuous operation at maximum output loading and worst case input line voltage with forced-air cooling at 25°C. N2Power does not warrant the MTBF to be representative of any particular unit. The MTBF of the power supply is calculated with an 80% confidence level in accordance with Bellcore, TR-332, Issue 6. Actual failure rates vary from unit to unit.

4.3 Component Stress

The XL275-DC was designed with the following component-derating guidelines at an operating ambient temperature of 50°C: semiconductor junction temperatures shall not exceed ninety (90) percent of manufacturer's rating. Inductor winding temperatures shall not exceed safety agency requirements. Electrolytic capacitor case temperatures shall not exceed 95% of rated temperature. Resistor power dissipation shall not exceed 70% of rated while other components will not be operated at more than 90% of their rated voltage or current.

4.4 Labeling/Marking

The power supply is marked and labeled with the N2Power logo model number, part number, input and output specifications, production code, appropriate safety agency logos, CE mark, and country of origin. A typical label is pictured below.

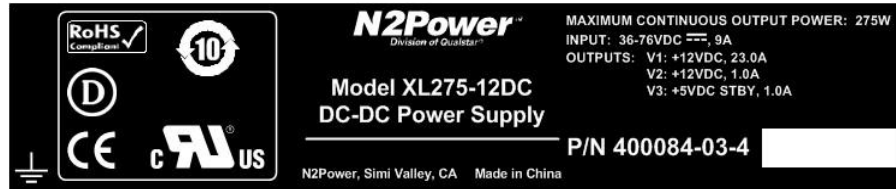

Figure 4-1 Sample XL275-DC Label

4.5 Weight

Units	XL275-DC
Pounds	1.0
Ounces	16
Kilograms	0.45

Table 4-2 Net Weight of a Single XL275-DC

4.6 Physical Dimensions

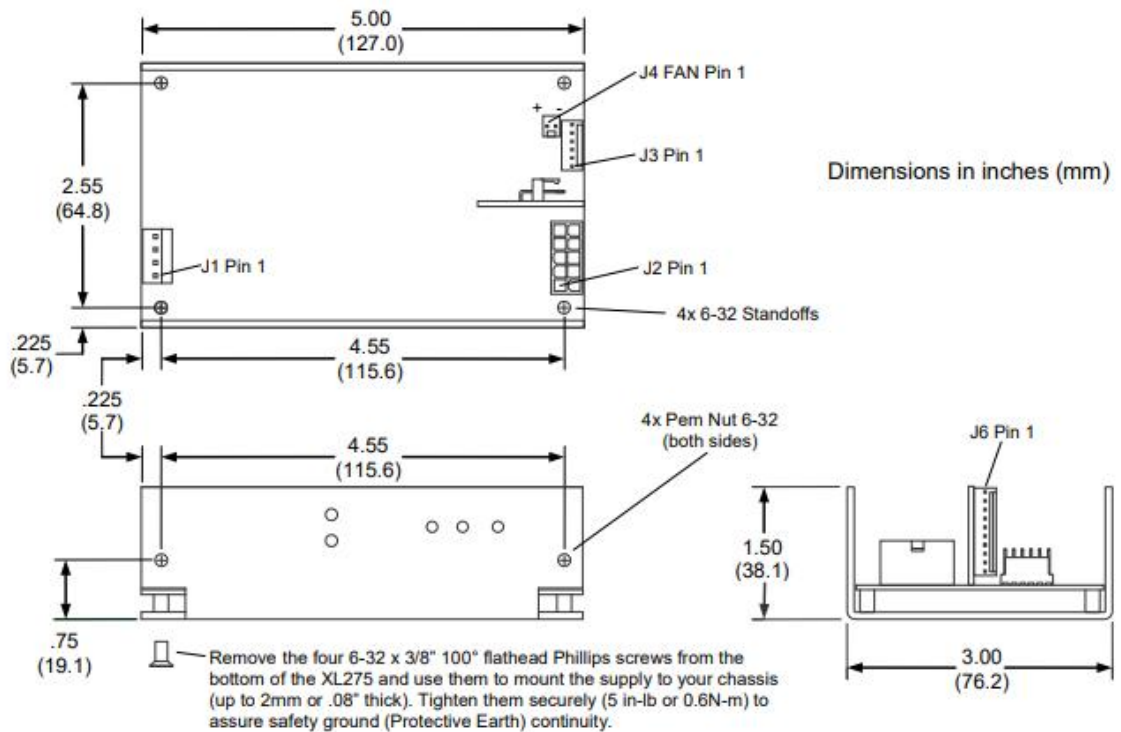

Figure 4-2 XL275-DC Dimensions

4.7 Mating Connectors

The user must furnish all mating connectors. The mating connectors must meet the requirements of all applicable safety agencies (notably UL). Molex™ (Molex is a trademark of the Molex Corporation) did not change their part numbers when they took the lead out of their contacts. The Molex part numbers in this section should yield RoHS compliant contacts. The largest wire size accepted by each contact should be used for all power connections to help dissipate the heat generated by the resistive connections.

Note that the female contacts that mate to the power supply are only rated for 25-30 mating cycles. Excessive mating cycles causes dramatically increased terminal resistance and heating resulting in the eventual failure of the mating terminal and possibly the header on the power supply.

CAUTION

The pin-1 location differs amongst connector manufacturers. Sometimes pin-1 differs between the header (on the power supply) and the mating housing from the same manufacturer. Disregard the manufacturer's pin-1 location and follow only the pin-1 locations in Figure 4-2.

4.7.1 AC Input Mating Connector J1

The DC input connector to the XL275-DC is a 4-pin Molex KK style header with 0.156" centers. Because of the high DC input currents, all four input terminals must be connected to the DC source. The Molex part numbers for the mating housing and crimp-style snap-in terminals are listed below. There may be equivalent connectors available from other manufacturers. AWG 18 wire is recommended.

J1	Molex P/N
Connector Circuits	4
PCB Header (tin)	26-60-4040
Mating Housing	09-50-3041
Rated Contact Current	7.0 A
Crimp Terminal (tin)	08-50-0106
Rated Wire Size	AWG 18 or 20

Table 4-3 J1 Mating Connector

4.7.2 DC Output Connector J2

The DC output connector is a Molex Mini-Fit, Jr.[®] header with 0.165” centers. The Molex part numbers for the mating housing and crimp-style snap-in terminals are listed below. There may be equivalent connectors available from other manufacturers. AWG 16 wire with the 39-00-0078 contact is recommended.

J2	Molex P/N	Rated AWG
Connector Circuits (pins)	10	
PCB Header	39-28-1103	
Mating Housing	39-01-2100	
Rated Contact Current	9.0 A	16
Recommended Crimp	39-00-0078	16
Alternate Crimp Terminal	39-00-0039	18-24

Table 4-4 J2 Mating Connector

4.7.3 Auxiliary Connector J3

The auxiliary connector on the XL275-DC is a Molex KK header with 0.100” centers. The Molex part numbers for the mating housing and crimp-style snap-in terminals are listed below. There may be equivalent connectors available from other manufacturers.

J3	Molex P/N
Connector Circuits (pins)	6
PCB Header	22-11-2062
Mating Housing with ramps &	22-01-3067
Crimp terminal (selective gold)	08-65-0816
Rated Contact Current	2.5 A
Rated Wire Size	AWG 22 thru 30

Table 4-5 J3 Mating Connector

4.7.4 FAN Connector J4

The FAN connector on the XL275-DC is a Molex KK header with 0.100” centers. The Molex part numbers for the mating housing and crimp-style snap-in terminals are listed below. There may be equivalent connectors available from other manufacturers.

J4	Molex P/N
Connector Circuits (pins)	2
PCB Header (Tinned)	22-11-2022
Mating Housing with ramps &	22-01-3027
Crimp terminal (selective gold)	08-65-0816
Rated Contact Current	2.5 A
Rated Wire Size	AWG 22 thru 30

Table 4-6 J4 Mating Connector

4.7.5 J5 Mating Connector

J5 is used internally, thus no mating connector is required.

4.7.6 Control Connector J6

The control connector is a Molex KK header with 0.100” centers. The Molex part numbers for the mating housing and crimp-style snap-in terminals are listed below. There may be equivalent connectors available from other manufacturers.

J6	Molex P/N
Connector Circuits (pins)	10
PCB Header (Gold)	22-12-2104
Mating Housing with ramps &	22-01-3107
Crimp terminal (selective gold)	08-65-0816
Rated Contact Current	2.5 A
Rated Wire Size	AWG 22 thru 30

Table 4-7 J6 Mating Connectors

4.8 Signal Descriptions and Remarks

Signal	Description/Remarks
DC +Input	The positive side of the DC input source
DC -Input	The negative side of the DC input source
V1	The main output (+) capable of 275W. It is recommended that all four output pins be wired in parallel.
V1 Sense (+)	Remote sense for V1 at load (compensates for wiring losses)
V1 Sense (-)	Remote sense for DC Return at load (affects V1, see above)
V1 Trim Input	Connect a resistor between this pin and DC Return to increase the V1 output voltage. Connect a resistor between this pin and V1 to decrease the output voltage. See Section 3.2
V1 Current Share	This analog signal is both an input and output and is used to evenly distribute the total load current amongst two or more XL275-DC power supplies wired in parallel. The signal also indicates the approximate load current of any single power supply. See Section 3.5.
V2 (+12V _{aux})	Provides 1A of 12V power for fans. Uses common ground DC Return. Turns off with V1
V3 (+5 V _{standby})	Provides 1A of 5V power whenever AC power is presents. Uses common ground DC Return
PS_ON	A low-logic level enables the V1 and V2 outputs. Pulled-up by 5K resistor to +4.5V. Factory default is shorted to DC Return with removable jumper. See Section 5.5
Power Good	A high-logic level (4.5V) indicates the output power is in regulation for at least the next 2mS. See Section 5.2
Power Good LED	Connect to the anode of an LED whose cathode is connected to DC Return. Will illuminate the LED when Power Good is high. See Section 5.2
Standby LED	Connect to the anode of an LED whose cathode is connected to DC Return. Will illuminate the LED when PS_ON is open or high. See Section 5.3
Fan 2: Tachometer Input	The tachometer output of a single fan may be connected to this input. The loss of the tachometer signal is detected and can be reported over the optional serial data interface.
Fan 2: Controlled Output	This output can drive a 12V fan and turns on only when the ambient temperature approaches the normal operating limits. See Section 3.10
PMBus Serial Data	Optional: Provides PMBus TM control/status interface
PMBus Serial Clock	Optional: Provides PMBus TM control/status interface

Table 4-8 Signal Descriptions and Remarks

Pin	Signal
J1-1	DC +Input
J1-2	DC +Input
J1-3	DC –Input
J1-4	DC –Input
Pin	Signal
J2-1	V1 (+ Output)
J2-2	V1 (+ Output)
J2-3	V1 (+ Output)
J2-4	V1 (+ Output)
J2-5	V1 Sense (+)
J2-6	DC Return
J2-7	DC Return
J2-8	DC Return
J2-9	DC Return
J2-10	V1 Sense (–)
Pin	Signal
J3-1	V1 Trim Input
J3-2	V3 (+5V Standby)
J3-3	DC Return
J3-4	V1 Current Share
J3-5	DC Return
J3-6	V2 (+12V _{aux})
Pin	Signal
J4-1	V2 (+12V _{aux} (Fan 1))
J4-2	DC Return
Pin	Signal
J6-1	Fan 2: Tachometer Input
J6-2	PMBus Serial Data
J6-3	PMBus Serial Clock
J6-4	Power Good (output, high-true)
J6-5	Power Good LED (+output)
J6-6	Standby LED (+output)
J6-7	DC Return
J6-8	PS_ON (input, low-true)
J6-9	DC Return
J6-10	Fan 2: Controlled Output (derived from +12V _{aux})

Table 4-9 Pin Assignments in Pin Order

Signal	Pin
DC Return	J2-6
DC Return	J2-7
DC Return	J2-8
DC Return	J2-9
DC Return	J3-3
DC Return	J3-5
DC Return	J4-2
DC Return	J6-7
DC Return	J6-9
V1 (+ Output)	J2-1
V1 (+ Output)	J2-2
V1 (+ Output)	J2-3
V1 (+ Output)	J2-4
V1 Sense (–)	J2-10
V1 Sense (+)	J2-5
V1 Trim Input	J3-1
V1 Current Share	J3-4
V2 (+12V _{aux})	J3-6
V2 (+12V _{aux} (Fan 1))	J4-1
V2-Switched +12V _{aux} (Fan 2)	J6-10
Fan 2 Tachometer Input	J6-1
V3 (+5V _{standby})	J3-2
PS_ON (input, low-true)	J6-8
Power Good (output, high-true)	J6-4
Power Good LED (+output)	J6-5
Standby LED (+output)	J6-6
PMBus Serial Data	J6-2
PMBus Serial Clock	J6-3

Table 4-10 Pin Assignments in Signal Order

All outputs and inputs are referred to DC Return. See Section 3.2 for details

5.

Timing and Control

5.1 Power Supply Timing

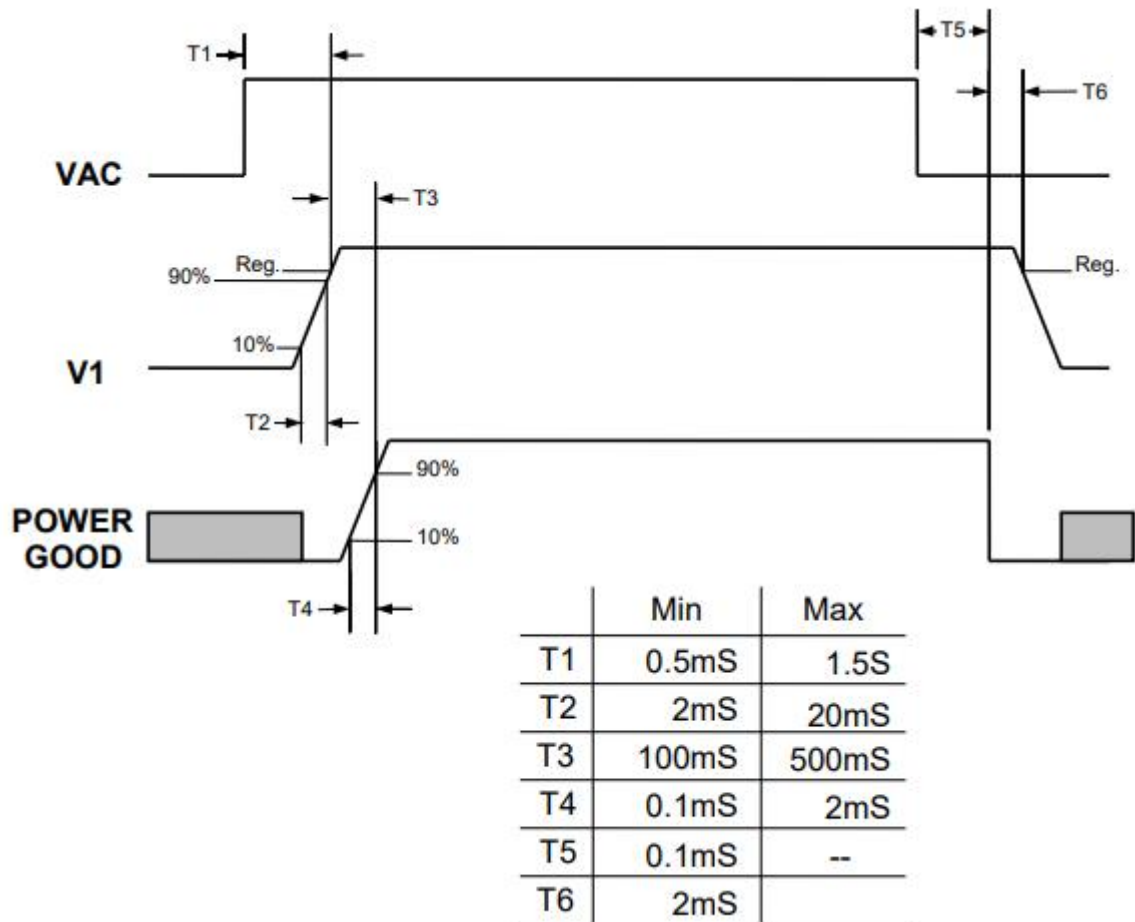

Figure 5-1 XL275-DC Timing Diagram

5.2 Power Good: Outputs and LED

The Power Good signal provides a high logic level to indicate the DC outputs are stabilized within their regulation tolerance. It will drop a minimum of 2mS before the main output is turned off except in the case of immediate loss of input power at high- loads. The Power Good signal is a CMOS capable of sinking 20mA or sourcing 10mA. The green onboard Power Good LED (located behind J6) illuminates whenever the Power Good output is high.

The Power Good LED output follows the logical Power Good output but is intended to drive an external LED through an internal 470-ohm ballast resistor from a 4.4V source. The cathode of the external LED should be connected to DC Return.

5.3 Standby LED Output

The Standby LED output is designed to directly drive an LED from an internal 4.4V source through an internal 470-ohm ballast resistor. This output will go high when the PS_ON input is open or false, meaning the main output is disabled. The cathode of the external LED should be connected to DC Return.

5.4 VIN LED

The amber VIN LED illuminates whenever there is sufficient DC input voltage to operate the +5V_{standby} supply. The LED is located immediately behind J3. **The XL275-DC should not be handled as long as this LED is illuminated.**

5.5 PS_ON Input

This input must be grounded to enable the V1 (main) and V2 (+12V_{aux}) outputs. It has no effect on +5V_{standby}. It is pulled up to 4.5V through a 5.0K resistor. The input voltage must be less than 0.4V when the output is to be activated and higher than 3.0V when the output is to be disabled. A jumper from J6-8 to J6-7 or J6-9 will enable the main and +12V_{aux} outputs (factory default: removable jumper installed J6-8 to J6-9). The PS_ON signal must remain in its changed state for 20mS before the change is accepted.

After a steady high level PS_ON signal is detected, the Power Good signal is de-asserted for a minimum of 2mS and a maximum of 4mS before disabling the outputs and starting a 4.2 second restart inhibit timer.

The PS_ON signal must be set low for a minimum of 20mS before the outputs can be enabled. However, the outputs must remain off for a minimum of 4.2 seconds each time they are turned off. This power-off pause is necessary to limit the internal power dissipation to safe levels under fault conditions. Simply leave the PS_ON signal low and the outputs will be automatically re-enabled when it is safe to do so.

There are output enable and disable commands available in the optional PMBus interface. These commands can override the state of the PS_ON input. Likewise, the PS_ON input can override the last PMBus command. Just remember that the last commanded on/off state (from interface pin or PMBus) will always take precedence.

The special order S91 option changes the logic sense of the PS_ON input from low-true with a pull-up resistor to high-true with a pull-down resistor. The S91 option requires ordering V3.x firmware. Consult sales for details.

5.6 Voltage Hold-Up Time

There is no output holdup time akin to the 22-milliseconds seen on AC input XL275s.

5.7 Output Rise Time

For single supply applications, all output voltages shall rise monotonically (always positive slope) from 10% to 90% of their nominal output voltage (as specified in Table 3-1) within 0.2ms to 20ms under any loading conditions specified in Table 3-3.

5.8 Overshoot at Turn-On/Turn-Off

The output voltage overshoot upon the application or removal of the input mains voltage is less than 10% above the nominal voltage. No opposite polarity voltage is present on any output during turn-on or turn-off.

6. Ordering Information

The following table provides the N2Power part numbers that should appear on your purchase order and on any N2Power correspondence. The CS versions add an active current sharing feature. All XL275-DC power supplies are RoHS compliant.

Model Number	V1	N2Power Part Number
Without active current sharing (lower cost)		
XL275-12DC	12 V	400084-03-4
XL275-24DC	24 V	400084-05-9
XL275-48DC	48 V	400084-06-7
XL275-54DC	54 V	400084-09-1
XL275-56DC	56 V	400084-10-9
With active current sharing (CS)		
XL275-12DC CS	12 V	400085-03-1
XL275-24DC CS	24 V	400085-05-6
XL275-48DC CS	48 V	400085-06-4
XL275-54DC CS	54 V	400085-09-8
XL275-56DC CS	56 V	400085-10-6

Table 6-1 XL275-DC Part Numbers

All XL275 models are RoHS compliant.

For warranty information refer to www.n2power.com

Direct all questions, orders or requests for quotation as follows:

N2Power Order Desk:	orders@n2power.com 805-583-7744 x112
Fax (Attention N2Power):	805-583-7749
Sales:	sales@n2power.com 805-583-7744 x122
Technical Support	techsupport@n2power.com 805-583-7744 x119
Street Address:	N2Power 130 W. Cochran St., Suite C Simi Valley CA 93065

7.

Customization

The XL275-DC is very modular in its design and allows for customization when sufficient quantities are ordered. The following options are available. Please contact sales@n2power.com for complete details.

Item	Description	Benefit	Detriment
1	Eliminate +12V _{aux} output.	Reduce cost	May have to provide fan power from another source.
2	Change main output voltage	Meet special requirements and reduce system costs	Increase power supply cost
3	Custom Micro-code	Meet unique system requirements	Development time and cost
4	S91 Option	High-True PS_ON Input with pull-down resistor	Not a stocked item and may cost extra

Table 7-1 XL275-DC Customization Options